

Product Overview	E-2
------------------------	-----

High Power Connector Systems (15 to 60A)

EXtreme LPHPower™	E-3 to E-13
EXtreme Ten60Power™	E-14 to E-17
EXtreme PowerEdge™	E-18 to E-20
Mini-Fit Sr.™	E-21 to E-27
EXtreme ZPower™	E-27
Expandable Power and Signal Connectors – EXtreme PowerPlus™	E-28 to E-31
5.00mm (.197") Pitch Connectors	E-32 to E-33
HCS-125	E-34 to E-35
Sabre™	E-36 to E-41
1.80mm (.070") Pitch Connectors – VersaBlade™	E-42 to E-46

Medium to High Power Connector Systems (3 to 5A)

Standard .093" and 3191 Pin and Socket	E-47 to E-51
MLX™	E-52 to E-54
6.50mm (.256") Pitch Wire-to-Board Connectors	E-55 to E-56
Mini-Fit® Overview	E-57 to E-58
Mini-Fit Plus™	E-59 to E-60
Mini-Fit Jr.™	E-61 to E-67
Mini-Fit Plus HCS™	E-68 to E-72
Mini-Fit BMI™	E-73 to E-79
Mini-Fit Plus HMC™	E-80 to E-83
Mini-Fit TPA™	E-84 to E-86
Mini-Fit RTC™	E-87
Mini-Fit PCIe	E-88 to E-90
Mini-Fit Family Test Plug	E-90

Low Power Connector Systems (3 to 5A)

Micro-Fit 3.0™	E-91 to E-105
Micro-Fit 3.0 BMI™	E-105 to E-108
Micro-Fit 3.0 BMI CPI™	E-108 to E-109
Standard .062" Pin and Socket	E-110 to E-111
2.50mm (.098") Pitch Connectors	E-112

Specialty Power Connectors

PC Board Terminals	E-112
Panel Grounding Clip	E-113
Cluster Block Connectors	E-113
3-in-1 Combo Connector	E-114
Battery Connectors	E-114 to E-115

Visit www.molex.com to access more part numbers and product information, download sales drawings, product specifications, 3D models, place sample requests, and more.

Power Connectors

REFERENCE CHART

	Description	Current Ratings at Smallest/ Largest Circuit Size	Operating Voltage	Housing Lock Method	Configurations Available	Connector Engaging Force Per Circuit	Fully-Isolated Contacts	Agency Ratings	Circuit Sizes Available	Wire Gauge	Flammability Rating
EXTreme Ten60™	Ten60 is a custom configurable connector system featuring a module design giving it the flexibility to provide virtually any arrangement of AC Power, DC Power, and signal lines	60/47A	600V	None	B-to-B	1.68 lbs. ⁵	No	UL CSA TUV	1-10 for Power, 6-36 for Signal	N/A	94V-0
Mini-Fit Sr.™	Mini-Fit Sr. is Molex's most robust power connector capable of carrying up to 50 amperes per circuit using 8 AWG wire	50/36A	600V	Pos.	W-to-W, W-to-B	6.61 lbs.	Yes	UL CSA TUV	2, 3, 4, 5, 6, 8, 10, 12, 14	8, 10, 12, 14, 16	94V-0
EXTreme PowerEdge™	Power Edge is vertical, high current connector assembly for mating to a .062" thick card edge or bus bar. Individual assemblies are available in power, signal or mixed power and signal orientations	40/26 ¹	250V	None	B-to-B	2.0 lbs., 0.31 lbs. ²	No	UL CSA TUV	2-8 for Power, 16-32 for Signal	N/A	94V-0
EXTreme LPHPower™	LPH is a versatile, co-planer board-to-board connector system combining signal and power circuits. Its low profile design enhances system airflow	30/22A ³	250V	None	B-to-B	1.54 lbs., 0.24 lbs. ⁴	Yes	UL CSA TUV	12-40 for Signal, 4-10 for Power	N/A	94V-0
HCS-125	HCS-125 is a high current, economical power connector capable of carrying up to 20 amperes per circuit in a wire-to-wire configuration	20/20A	600V	Pas.	W-to-W	5.75 lbs.	Yes	UL CSA TUV	1, 2, 3, 4	10-14, 16-18	94V-2
Sabre™	Sabre's current carrying capability fits between the Mini-Fit Jr. and Mini-Fit Sr. offering up to 18 amperes per circuit at 600 volts	18/18A	600V	Pos.	W-to-W, W-to-B	3.0 lbs.	Yes	UL CSA	2, 3, 4, 5, 6	14-18	94V-2 94V-0
Versablade™	VersaBlade's 1.80mm (.070") wire-to-wire connectors are designed around an industry standard 070" width male "tab" style terminal	15A	300V	Pos.	W-to-W	2.3 lbs.	Yes	UL TUV	1, 2, 3, 4, 6	14-22	94V-0
Standard .093"	The .093" is an industry standard connector system utilized in many different power applications	14/9.5A*	250V	Pas.	W-to-W, W-to-B	3.5 lbs.	Yes	UL CSA	1, 2, 3, 4, 5, 6, 9, 12, 15	14-30	94V-2
3191	The 3191 series is a positive locking, 600V connector system that uses Standard .093" terminals	12/9A*	600V	Pos.	W-to-W, W-to-B	3.5 lbs.	Yes	UL CSA TUV	1, 2, 3, 4, 6, 9, 12, 15	14-30	94V-2 94V-0
MLX	The MLX family is an industry compatible line of 2.13mm (.084") diameter plug, cap, and header connections. It is intermountable, intermateable, and interchangeable with industry standard products	13.5/11A	600V	Pos.	W-to-W, W-to-B	1.51 lbs.	Yes	UL CSA	1, 2, 3, 4, 6, 9, 12, 15	14-20, 13-16, 10-12	94V-2 94V-0
Mini-Fit Plus HCS™	Mini-Fit Plus HCS (High Current System) is capable of carrying up to 12 amperes per circuit. The terminals fit in all Mini-Fit plugs and receptacles	12/11A	600V	Pos.	W-to-W, W-to-B, B-to-B	1.54 lbs.	Yes	Pending	2, 3, 4, 5, 6, 8, 10, 12, 14, 16, 18, 20, 22, 24	16, 18-20	94V-2 94V-0
Mini-Fit Plus HMC™	Mini-Fit High Cycle is capable of mated and unmated hundreds of times and still provide reliable electrical connections. It is available only in the BMI format	12/11A	600V	None	W-to-W, W-to-B, B-to-B	1.54 lbs.	Yes	Pending	4, 6, 10, 14, 18, 24	16, 18-20, 22-24	94V-0
Mini-Fit Jr.™	Mini-Fit Jr. is a high current/high density power connector offering great design flexibility for W-to-W and W-to-B housing configurations	9/6A	600V	Pos.	W-to-W, W-to-B	1.54 lbs.	Yes	UL CSA TUV	2, 3, 4, 5, 6, 8, 10, 12, 14, 16, 18, 20, 22, 24	16, 18-20, 22-24	94V-2 94V-0
Mini-Fit TPA™	Mini-Fit TPA allows terminals to be fully seated in the housing assuring that they will not back out, providing added security with a secondary locking mechanism	9/6A	600V	Pos.	W-to-W, W-to-B	1.54 lbs.	Yes	UL CSA TUV	2, 4, 6, 8, 10, 12, 16	16, 18-24, 22-28	94V-0
Mini-Fit BMI™ (SMC)	Mini-Fit SMC is made of high temperature material which allows it to withstand the wave/IR soldering processes	12/11A	600V	None	W-to-B, B-to-B	1.54 lbs.	Yes	UL CSA TUV	4, 6, 10, 14, 18, 24	16, 18-20	94V-0
Mini-Fit BMI™	Mini-Fit BMI (Blind Mate Interface) power connectors are designed for applications requiring the blind mating of modules, subassemblies or printed circuit boards	8/6A	600V	None	W-to-W, W-to-B, B-to-B	1.54 lbs.	Yes	UL CSA TUV	4, 6, 10, 14, 18, 24, 36, 40	16, 18-20, 22-24	94V-2 94V-0
Mini-Fit BMI™ (CPI)	Mini-Fit BMI™ CPI offers a unique compliant pin design which requires no soldering	7A	600V	None	W-to-B, B-to-B	1.54 lbs.	Yes	UL CSA TUV	4, 6, 10, 14, 18, 24	16, 18-20, 22-24	94V-0
KK®-156 KK-100	Molex KK is a complete interconnection system for W-to-W and B-to-B applications in .100", .156" and .200" centerlines	7/5A	250V	Pas.	W-to-W, W-to-B	2.25 lbs.	Yes	UL CSA TUV	2-20	18-22	94V-2 94V-0
Micro-Fit 3.0™	Micro-Fit 3.0 is a unique interconnect system designed to meet the need for a rugged signal connector and incorporates many of the features previously found only on larger power connectors	5/1A	250V	Pos.	W-to-W, W-to-B	2.2 lbs.	Yes	UL CSA TUV	2, 3, 4, 5, 6, 8, 10, 12, 14, 16, 18, 20, 22, 24	22, 24, 26, 28, 30	94V-0
Micro-Fit 3.0 BMI™	Micro-Fit 3.0 BMI (Blind Mate Interface) features a self-guiding funnel, allowing connections in those hard to reach applications	5/1A	250V	None	W-to-W, W-to-B, B-to-B	2.2 lbs.	Yes	UL CSA TUV	2, 4, 6, 8, 10, 12, 14, 16, 18, 20, 22, 24	20, 22, 24, 26, 28, 30	94V-0
Standard .062"	The .062" is a durable and economical power or signal connector, capable of carrying up to 5.0 amperes per circuit	5/4A	250V	Pas.	W-to-W	2.3 lbs.	Yes	UL CSA TUV	1, 2, 3, 4, 5, 6, 9, 12, 15, 24, 36	18-24, 24-30	94V-2

N/A—Not Applicable

¹Power Edge signal contacts are rated at 3A and 250V per circuit. See product series 45844, 45845, 45911 and 45912 for more information.

²Power contact engagement force is 2.0 lbs.; signal contact engagement force 0.31 lbs.

³LPH signal contacts for product series 45984 and 45985 are rated at 1A and 250V per circuit.

⁴Power contact engagement force is 1.54 lbs.; Signal contact engagement force is 0.24 lbs.

⁵3 additional amperes per circuit can be achieved when used with High Current terminals.

⁶Mating force is based on Vertical Power Receptacle. See product specification for Signal and Right Angle Power.

EXTreme LPHPower™ Low Profile Hybrid PCB Receptacle

45984

Right Angle, 4 Power Contacts

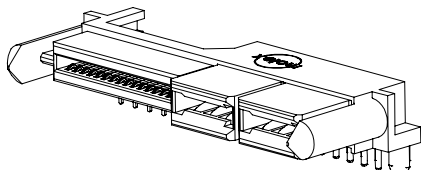

Features and Benefits

- Low Profile Hybrid (LPH) receptacle header combines mixed power and signal contacts for high current, coplanar, board-to-board applications
- Horizontal contact design provides low profile height at only 7.49mm (.295") max. for improved air flow

Reference Information

Product Specification: PS-45984-001
 Packaging: Tray
 UL File No.: E29179
 CSA File No.: LR19980
 Mates With: 45985 headers or 1.57mm (.062") thick card edge
 Designed In: Millimeters

Electrical

Voltage: 250V
 Current: Power Contacts—30.0A max.
 Signal Contacts—1.0A max.
 Current Interruption: Power—30.0A at 42VDC
 Signal—1.0A at 30V
 Contact Resistance: Power Contacts—0.75 milliohms max.
 Signal Contacts—15 milliohms max.
 Insulation Resistance: 5000 Megohms min.

Mechanical

Mating Force: Single Power Contact—6.87N (1.54 lb.) Nom.
 Single Signal Contact—1.08N (0.24 lb.) Nom.
 Unmating Force:
 Single Power Contact—5.88N (1.32 lb.) Nom.
 Single Signal Contact—0.02N (0.03 lb.) Nom.
 Durability: 250 Cycles

Physical

Housing: LCP, UL 94V-0
 Contact: Copper Alloy
 Plating: Contact Area—Select Gold
 Solder Tail Area—Tin
 Underplating—Nickel

No. of Signal Pins	Order No.				PC Tail Length	PCB Thickness	Lead-free
	No PCB Pegs or BMI Guides	BMI Guides, No PCB Pegs	PCB Pegs, No BMI Guides	PCB Pegs and BMI Guides			
0	45984-4911	45984-4912	45984-4913	45984-4914	4.50mm (.177")	3.18mm (.125")	
12	45984-4111	45984-4211	45984-4311	45984-4411			
16	45984-4121	45984-4221	45984-4321	45984-4421			
20	45984-4131	45984-4231	45984-4331	45984-4431			
24	45984-4141	45984-4241	45984-4341	45984-4441			
28	45984-4151	45984-4251	45984-4351	45984-4451			
32	45984-4161	45984-4261	45984-4361	45984-4461			
36	45984-4171	45984-4271	45984-4371	45984-4471			
40	45984-4181	45984-4281	45984-4381	45984-4481			
0	45984-4921	45984-4922	45984-4923	45984-4924			
12	45984-4112	45984-4212	45984-4312	45984-4412			
16	45984-4122	45984-4222	45984-4322	45984-4422			
20	45984-4132	45984-4232	45984-4332	45984-4432			
24	45984-4142	45984-4242	45984-4342	45984-4442			
28	45984-4152	45984-4252	45984-4352	45984-4452			
32	45984-4162	45984-4262	45984-4362	45984-4462			
36	45984-4172	45984-4272	45984-4372	45984-4472			
40	45984-4182	45984-4282	45984-4382	45984-4482			
0	45984-4931	45984-4932	45984-4933	45984-4934	2.90mm (.114")	1.57mm (.062")	
12	45984-4113	45984-4213	45984-4313	45984-4413			
16	45984-4123	45984-4223	45984-4323	45984-4423			
20	45984-4133	45984-4233	45984-4333	45984-4433			
24	45984-4143	45984-4243	45984-4343	45984-4443			
28	45984-4153	45984-4253	45984-4353	45984-4453			
32	45984-4163	45984-4263	45984-4363	45984-4463			
36	45984-4173	45984-4273	45984-4373	45984-4473			
40	45984-4183	45984-4283	45984-4383	45984-4483			

EXTreme LPHPower™ Low Profile Hybrid PCB Receptacle

45984

Right Angle, 6 Power Contacts

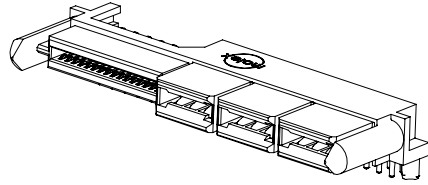

Features and Benefits

- Low Profile Hybrid (LPH) receptacle header combines mixed power and signal contacts for high current, coplanar, board-to-board applications
- Horizontal contact design provides low profile height at only 7.49mm (.295") max. for improved air flow

Reference Information

Product Specification: PS-45984-001
 Packaging: Tray
 UL File No.: E29179
 Mates With: 45985 Headers or 1.57mm (.062") thick card edge
 Designed In: Millimeters

Electrical

Voltage: 250V
 Current: Power Contacts—30.0A max.
 Signal Contacts—1.0A max.
 Current Interruption: Power—30.0A at 42VDC
 Signal—1.0A at 30V
 Contact Resistance: Power Contacts—0.75 milliohms max.
 Signal Contacts—15 milliohms max.
 Insulation Resistance: 5000 Megohms min.

Mechanical

Mating Force: Single Power Contact—6.87N (1.54 lb.) Nom.
 Single Signal Contact—1.08N (0.24 lb.) Nom.
 Unmating Force:
 Single Power Contact—5.88N (1.32 lb.) Nom.
 Single Signal Contact—0.02N (0.03 lb.) Nom.
 Durability: 250 Cycles

Physical

Housing: LCP, UL 94V-0
 Contact: Copper Alloy
 Plating: Contact Area—Select Gold
 Solder Tail Area—Tin
 Underplating—Nickel

No. of Signal Pins	Order No.				PC Tail Length	PCB Thickness	Lead-free
	No PCB Pegs or BMI Guides	BMI Guides, No PCB Pegs	PCB Pegs, No BMI Guides	PCB Pegs and BMI Guides			
0	45984-6911	45984-6912	45984-6913	45984-6914	4.50mm (.177")	3.18mm (.125")	
12	45984-6111	45984-6211	45984-6311	45984-6411			
16	45984-6121	45984-6221	45984-6321	45984-6421			
20	45984-6131	45984-6231	45984-6331	45984-6431			
24	45984-6141	45984-6241	45984-6341	45984-6441			
28	45984-6151	45984-6251	45984-6351	45984-6451			
32	45984-6161	45984-6261	45984-6361	45984-6461			
36	45984-6171	45984-6271	45984-6371	45984-6471			
40	45984-6181	45984-6281	45984-6381	45984-6481			
0	45984-6921	45984-6922	45984-6923	45984-6924			
12	45984-6112	45984-6212	45984-6312	45984-6412			
16	45984-6122	45984-6222	45984-6322	45984-6422			
20	45984-6132	45984-6232	45984-6332	45984-6432			
24	45984-6142	45984-6242	45984-6342	45984-6442			
28	45984-6152	45984-6252	45984-6352	45984-6452			
32	45984-6162	45984-6262	45984-6362	45984-6462			
36	45984-6172	45984-6272	45984-6372	45984-6472			
40	45984-6182	45984-6282	45984-6382	45984-6482			
0	45984-6931	45984-6932	45984-6933	45984-6934	2.90mm (.114")	1.57mm (.062")	
12	45984-6113	45984-6213	45984-6313	45984-6413			
16	45984-6123	45984-6223	45984-6323	45984-6423			
20	45984-6133	45984-6233	45984-6333	45984-6433			
24	45984-6143	45984-6243	45984-6343	45984-6443			
28	45984-6153	45984-6253	45984-6353	45984-6453			
32	45984-6163	45984-6263	45984-6363	45984-6463			
36	45984-6173	45984-6273	45984-6373	45984-6473			
40	45984-6183	45984-6283	45984-6383	45984-6483			

EXTreme LPHPower™ Low Profile Hybrid PCB Receptacle

45984

Right Angle, 8 Power Contacts

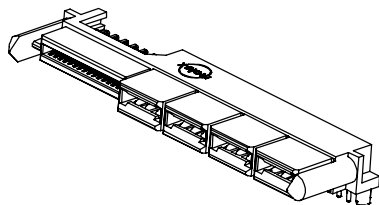

Features and Benefits

- Low Profile Hybrid (LPH) receptacle header combines mixed power and signal contacts for high current, coplanar, board-to-board applications
- Horizontal contact design provides low profile height at only 7.49mm (.295") max. for improved air flow

Reference Information

Product Specification: PS-45984-001

Packaging: Tray

UL File No.: E29179

Mates With: 45985 Headers or 1.57mm (.062") thick card edge

Designed In: Millimeters

Electrical

Voltage: 250V

Current: Power Contacts—30.0A max.

Signal Contacts—1.0A max.

Current Interruption: Power—30.0A at 42VDC

Signal—1.0A at 30V

Contact Resistance: Power Contacts—0.75 milliohms max.

Signal Contacts—15 milliohms max.

Insulation Resistance: 5000 Megohms min.

Mechanical

Mating Force: Single Power Contact—6.87N (1.54 lb.) Nom.

Single Signal Contact—1.08N (0.24 lb.) Nom.

Unmating Force:

Single Power Contact—5.88N (1.32 lb.) Nom.

Single Signal Contact—0.02N (0.03 lb.) Nom.

Durability: 250 Cycles

Physical

Housing: LCP, UL 94V-0

Contact: Copper Alloy

Plating: Contact Area—Select Gold

Solder Tail Area—Tin

Underplating—Nickel

No. of Signal Pins	Order No.				PC Tail Length	PCB Thickness	Lead-free
	No PCB Pegs or BMI Guides	BMI Guides, No PCB Pegs	PCB Pegs, No BMI Guides	PCB Pegs and BMI Guides			
0	45984-8911	45984-8912	45984-8913	45984-8914	4.50mm (.177")	3.18mm (.125")	
12	45984-8111	45984-8211	45984-8311	45984-8411			
16	45984-8121	45984-8221	45984-8321	45984-8421			
20	45984-8131	45984-8231	45984-8331	45984-8431			
24	45984-8141	45984-8241	45984-8341	45984-8441			
28	45984-8151	45984-8251	45984-8351	45984-8451			
32	45984-8161	45984-8261	45984-8361	45984-8461			
36	45984-8171	45984-8271	45984-8371	45984-8471			
40	45984-8181	45984-8281	45984-8381	45984-8481			
0	45984-8921	45984-8922	45984-8923	45984-8924			
12	45984-8112	45984-8212	45984-8312	45984-8412			
16	45984-8122	45984-8222	45984-8322	45984-8422			
20	45984-8132	45984-8232	45984-8332	45984-8432			
24	45984-8142	45984-8242	45984-8342	45984-8442			
28	45984-8152	45984-8252	45984-8352	45984-8452			
32	45984-8162	45984-8262	45984-8362	45984-8462			
36	45984-8172	45984-8272	45984-8372	45984-8472			
40	45984-8182	45984-8282	45984-8382	45984-8482			
0	45984-8931	45984-8932	45984-8933	45984-8934			
12	45984-8113	45984-8213	45984-8313	45984-8413			
16	45984-8123	45984-8223	45984-8323	45984-8423			
20	45984-8133	45984-8233	45984-8333	45984-8433			
24	45984-8143	45984-8243	45984-8343	45984-8443			
28	45984-8153	45984-8253	45984-8353	45984-8453			
32	45984-8163	45984-8263	45984-8363	45984-8463			
36	45984-8173	45984-8273	45984-8373	45984-8473			
40	45984-8183	45984-8283	45984-8383	45984-8483			

E

Power Connectors

EXTreme LPHPower™ Low Profile Hybrid PCB Receptacle

45984

Right Angle, 10 Power Contacts

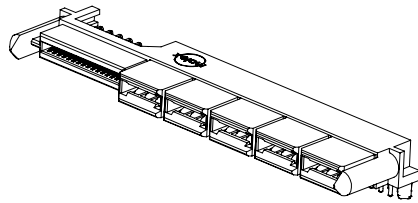

Features and Benefits

- Low Profile Hybrid (LPH) receptacle header combines mixed power and signal contacts for high current, coplanar, board-to-board applications
- Horizontal contact design provides low profile height at only 7.49mm (.295") max. for improved air flow

Reference Information

Product Specification: PS-45984-001
 Packaging: Tray
 UL File No.: E29179
 Mates With: 45985 headers or 1.57mm (.062") thick card edge
 Designed In: Millimeters

Electrical

Voltage: 250V
 Current: Power Contacts—30.0A max.
 Signal Contacts—1.0A max.
 Current Interruption: Power—30.0A at 42VDC
 Signal—1.0A at 30V
 Contact Resistance: Power Contacts—0.75 milliohms max.
 Signal Contacts—15 milliohms max.
 Insulation Resistance: 5000 Megohms min.

Mechanical

Mating Force: Single Power Contact—6.87N (1.54 lb.) Nom.
 Single Signal Contact—1.08N (0.24 lb.) Nom.
 Unmating Force:
 Single Power Contact—5.88N (1.32 lb.) Nom.
 Single Signal Contact—0.02N (0.03 lb.) Nom.
 Durability: 250 Cycles

Physical

Housing: LCP, UL 94V-0
 Contact: Copper Alloy
 Plating: Contact Area—Select Gold
 Solder Tail Area—Tin
 Underplating—Nickel

E

Power Connectors

No. of Signal Pins	Order No.				PC Tail Length	PCB Thickness	Lead-free
	No PCB Pegs or BMI Guides	BMI Guides, No PCB Pegs	PCB Pegs, No BMI Guides	PCB Pegs and BMI Guides			
0	45984-1911	45984-1912	45984-1913	45984-1914	4.50mm (.177")	3.18mm (.125")	Yes
12	45984-1111	45984-1211	45984-1311	45984-1411			
16	45984-1121	45984-1221	45984-1321	45984-1421			
20	45984-1131	45984-1231	45984-1331	45984-1431			
24	45984-1141	45984-1241	45984-1341	45984-1441			
28	45984-1151	45984-1251	45984-1351	45984-1451			
32	45984-1161	45984-1261	45984-1361	45984-1461			
36	45984-1171	45984-1271	45984-1371	45984-1471			
40	45984-1181	45984-1281	45984-1381	45984-1481			
0	45984-1921	45984-1922	45984-1923	45984-1924			
12	45984-1112	45984-1212	45984-1312	45984-1412			
16	45984-1122	45984-1222	45984-1322	45984-1422			
20	45984-1132	45984-1232	45984-1332	45984-1432			
24	45984-1142	45984-1242	45984-1342	45984-1442			
28	45984-1152	45984-1252	45984-1352	45984-1452			
32	45984-1162	45984-1262	45984-1362	45984-1462			
36	45984-1172	45984-1272	45984-1372	45984-1472			
40	45984-1182	45984-1282	45984-1382	45984-1482			
0	45984-1931	45984-1932	45984-1933	45984-1934	2.90mm (.114")	1.57mm (.062")	
12	45984-1113	45984-1213	45984-1313	45984-1413			
16	45984-1123	45984-1223	45984-1323	45984-1423			
20	45984-1133	45984-1233	45984-1333	45984-1433			
24	45984-1143	45984-1243	45984-1343	45984-1443			
28	45984-1153	45984-1253	45984-1353	45984-1453			
32	45984-1163	45984-1263	45984-1363	45984-1463			
36	45984-1173	45984-1273	45984-1373	45984-1473			
40	45984-1183	45984-1283	45984-1383	45984-1483			

EXTreme LPHPower™ Low Profile Hybrid Header

45985

Right Angle, 4 Power Contacts

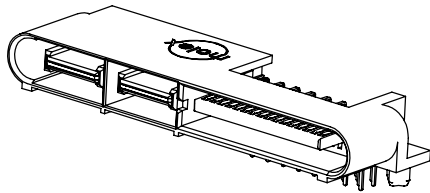

Features and Benefits

- Low Profile Hybrid (LPH) receptacle header combines mixed power and signal contacts for high current, coplanar, board-to-board applications
- Horizontal contact design provides low profile height at only 7.49mm (.295") max. for improved air flow

Reference Information

Product Specification: PS-45984-001
Packaging: Tray
UL File No.: E29179
Mates With: 45984 receptacles
Designed In: Millimeters

Electrical

Voltage: 250V
Current: Power Contacts—30.0A max.
Signal Contacts—1.0A max.
Current Interruption: Power—30.0A at 42VDC
Signal—1.0A at 30V
Contact Resistance: Power Contacts—0.75 milliohms max.
Signal Contacts—15 milliohms max.
Insulation Resistance: 5000 Megohms min.

Mechanical

Mating Force: Single Power Contact—6.87N (1.54 lb.) Nom.
Single Signal Contact—1.08N (0.24 lb.) Nom.
Unmating Force:
Single Power Contact—5.88N (1.32 lb.) Nom.
Single Signal Contact—0.02N (0.03 lb.) Nom.
Durability: 250 Cycles

Physical

Housing: LCP, UL 94V-0
Contact: Copper Alloy
Plating: Contact Area—Select Gold
Solder Tail Area—Tin
Underplating—Nickel

E

Power Connectors

No. of Signal Pins	Order No.				PC Tail Length	PCB Thickness	Lead-free
	No PCB Pegs or BMI Guides	BMI Guides, No PCB Pegs	PCB Pegs, No BMI Guides	PCB Pegs and BMI Guides			
0	45985-4911	45985-4912	45985-4913	45985-4914	4.50mm (.177")	3.18mm (.125")	
12	45985-4111	45985-4211	45985-4311	45985-4411			
16	45985-4121	45985-4221	45985-4321	45985-4421			
20	45985-4131	45985-4231	45985-4331	45985-4431			
24	45985-4141	45985-4241	45985-4341	45985-4441			
28	45985-4151	45985-4251	45985-4351	45985-4451			
32	45985-4161	45985-4261	45985-4361	45985-4461			
36	45985-4171	45985-4271	45985-4371	45985-4471			
40	45985-4181	45985-4281	45985-4381	45985-4481			
0	45985-4921	45985-4922	45985-4923	45985-4924			
12	45985-4112	45985-4212	45985-4312	45985-4412	3.60mm (.143")	2.36mm (.093")	Yes
16	45985-4122	45985-4222	45985-4322	45985-4422			
20	45985-4132	45985-4232	45985-4332	45985-4432			
24	45985-4142	45985-4242	45985-4342	45985-4442			
28	45985-4152	45985-4252	45985-4352	45985-4452			
32	45985-4162	45985-4262	45985-4362	45985-4462			
36	45985-4172	45985-4272	45985-4372	45985-4472			
40	45985-4182	45985-4282	45985-4382	45985-4482			
0	45985-4931	45985-4932	45985-4933	45985-4934			
12	45985-4113	45985-4213	45985-4313	45985-4413			
16	45985-4123	45985-4223	45985-4323	45985-4423	2.90mm (.114")	1.57mm (.062")	
20	45985-4133	45985-4233	45985-4333	45985-4433			
24	45985-4143	45985-4243	45985-4343	45985-4443			
28	45985-4153	45985-4253	45985-4353	45985-4453			
32	45985-4163	45985-4263	45985-4363	45985-4463			
36	45985-4173	45985-4273	45985-4373	45985-4473			
40	45985-4183	45985-4283	45985-4383	45985-4483			

EXTreme LPHPower™ Low Profile Hybrid Header

45985

Right Angle, 6 Power Contacts

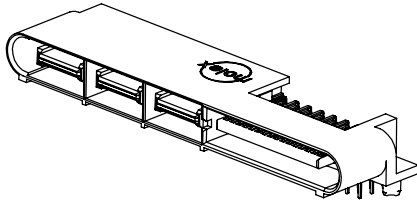

Features and Benefits

- Low Profile Hybrid (LPH) receptacle header combines mixed power and signal contacts for high current, coplanar, board-to-board applications
- Horizontal contact design provides low profile height at only 7.49mm (.295") max. for improved air flow

Reference Information

Product Specification: PS-45984-001
Packaging: Tray
UL File No.: E29179
Mates With: 45984 receptacles
Designed In: Millimeters

Electrical

Voltage: 250V
Current: Power Contacts—30.0A max.
Signal Contacts—1.0A max.
Current Interruption: Power—30.0A at 42VDC
Signal—1.0A at 30V
Contact Resistance: Power Contacts—0.75 milliohms max.
Signal Contacts—15 milliohms max.
Insulation Resistance: 5000 Megohms min.

Mechanical

Mating Force: Single Power Contact—6.87N (1.54 lb.) Nom.
Single Signal Contact—1.08N (0.24 lb.) Nom.
Unmating Force:
Single Power Contact—5.88N (1.32 lb.) Nom.
Single Signal Contact—0.02N (0.03 lb.) Nom.
Durability: 250 Cycles

Physical

Housing: LCP, UL 94V-0
Contact: Copper Alloy
Plating: Contact Area—Select Gold
Solder Tail Area—Tin
Underplating—Nickel

No. of Signal Pins	Order No.				PC Tail Length	PCB Thickness	Lead-free
	No PCB Pegs or BMI Guides	BMI Guides, No PCB Pegs	PCB Pegs, No BMI Guides	PCB Pegs and BMI Guides			
0	45985-6911	45985-6912	45985-6913	45985-6914	4.50mm (.177")	3.18mm (.125")	Yes
12	45985-6111	45985-6211	45985-6311	45985-6411			
16	45985-6121	45985-6221	45985-6321	45985-6421			
20	45985-6131	45985-6231	45985-6331	45985-6431			
24	45985-6141	45985-6241	45985-6341	45985-6441			
28	45985-6151	45985-6251	45985-6351	45985-6451			
32	45985-6161	45985-6261	45985-6361	45985-6461			
36	45985-6171	45985-6271	45985-6371	45985-6471			
40	45985-6181	45985-6281	45985-6381	45985-6481			
0	45985-6921	45985-6922	45985-6923	45985-6924			
12	45985-6112	45985-6212	45985-6312	45985-6412			
16	45985-6122	45985-6222	45985-6322	45985-6422			
20	45985-6132	45985-6232	45985-6332	45985-6432			
24	45985-6142	45985-6242	45985-6342	45985-6442			
28	45985-6152	45985-6252	45985-6352	45985-6452			
32	45985-6162	45985-6262	45985-6362	45985-6462			
36	45985-6172	45985-6272	45985-6372	45985-6472			
40	45985-6182	45985-6282	45985-6382	45985-6482			
0	45985-6931	45985-6932	45985-6933	45985-6934			
12	45985-6113	45985-6213	45985-6313	45985-6413			
16	45985-6123	45985-6223	45985-6323	45985-6423			
20	45985-6133	45985-6233	45985-6333	45985-6433			
24	45985-6143	45985-6243	45985-6343	45985-6443			
28	45985-6153	45985-6253	45985-6353	45985-6453			
32	45985-6163	45985-6263	45985-6363	45985-6463			
36	45985-6173	45985-6273	45985-6373	45985-6473			
40	45985-6183	45985-6283	45985-6383	45985-6483			

EXTreme LPHPower™ Low Profile Hybrid Header

45985

Right Angle, 8 Power Contacts

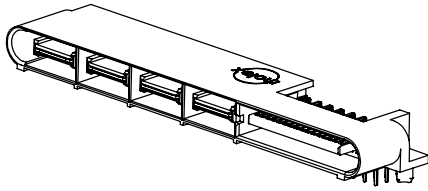

Features and Benefits

- Low Profile Hybrid (LPH) receptacle header combines mixed power and signal contacts for high current, coplanar, board-to-board applications
- Horizontal contact design provides low profile height at only 7.49mm (.295") max. for improved air flow

Reference Information

Product Specification: PS-45984-001
Packaging: Tray
UL File No.: E29179
Mates With: 45984 receptacles
Designed In: Millimeters

Electrical

Voltage: 250V
Current: Power Contacts—30.0A max.
Signal Contacts—1.0A max.
Current Interruption: Power—30.0A at 42VDC
Signal—1.0A at 30V
Contact Resistance: Power Contacts—0.75 milliohms max.
Signal Contacts—1.5 milliohms max.
Insulation Resistance: 5000 Megohms min.

Mechanical

Mating Force: Single Power Contact—6.87N (1.54 lb.) Nom.
Single Signal Contact—1.08N (0.24 lb.) Nom.
Unmating Force:
Single Power Contact—5.88N (1.32 lb.) Nom.
Single Signal Contact—0.02N (0.03 lb.) Nom.
Durability: 250 Cycles

Physical

Housing: LCP, UL 94V-0
Contact: Copper Alloy
Plating: Contact Area—Select Gold
Solder Tail Area—Tin
Underplating—Nickel

E

Power Connectors

No. of Signal Pins	Order No.				PC Tail Length	PCB Thickness	Lead-free
	No PCB Pegs or BMI Guides	BMI Guides, No PCB Pegs	PCB Pegs, No BMI Guides	PCB Pegs and BMI Guides			
0	45985-8911	45985-8912	45985-8913	45985-8914	4.50mm (.177")	3.18mm (.125")	
12	45985-8111	45985-8211	45985-8311	45985-8411			
16	45985-8121	45985-8221	45985-8321	45985-8421			
20	45985-8131	45985-8231	45985-8331	45985-8431			
24	45985-8141	45985-8241	45985-8341	45985-8441			
28	45985-8151	45985-8251	45985-8351	45985-8451			
32	45985-8161	45985-8261	45985-8361	45985-8461			
36	45985-8171	45985-8271	45985-8371	45985-8471			
40	45985-8181	45985-8281	45985-8381	45985-8481			
0	45985-8921	45985-8922	45985-8923	45985-8924			
12	45985-8112	45985-8212	45985-8312	45985-8412			
16	45985-8122	45985-8222	45985-8322	45985-8422			
20	45985-8132	45985-8232	45985-8332	45985-8432			
24	45985-8142	45985-8242	45985-8342	45985-8442			
28	45985-8152	45985-8252	45985-8352	45985-8452			
32	45985-8162	45985-8262	45985-8362	45985-8462			
36	45985-8172	45985-8272	45985-8372	45985-8472			
40	45985-8182	45985-8282	45985-8382	45985-8482			
0	45985-8931	45985-8932	45985-8933	45985-8934			
12	45985-8113	45985-8213	45985-8313	45985-8413			
16	45985-8123	45985-8223	45985-8323	45985-8423			
20	45985-8133	45985-8233	45985-8333	45985-8433			
24	45985-8143	45985-8243	45985-8343	45985-8443			
28	45985-8153	45985-8253	45985-8353	45985-8453			
32	45985-8163	45985-8263	45985-8363	45985-8463			
36	45985-8173	45985-8273	45985-8373	45985-8473			
40	45985-8183	45985-8283	45985-8383	45985-8483			

EXTreme LPHPower™ Low Profile Hybrid Header

45985
Right Angle, 10 Power Contacts

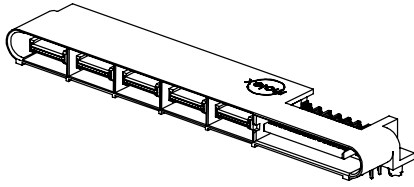

Features and Benefits

- Low Profile Hybrid (LPH) receptacle header combines mixed power and signal contacts for high current, coplanar, board-to-board applications
- Horizontal contact design provides low profile height at only 7.49mm (.295") max. for improved air flow

Reference Information

Product Specification: PS-45984-001
Packaging: Tray
UL File No.: E29179
Mates With: 45984 receptacles
Designed In: Millimeters

Electrical

Voltage: 250V
Current: Power Contacts—30.0A max.
Signal Contacts—1.0A max.
Current Interruption: Power—30.0A at 42VDC
Signal—1.0A at 30V
Contact Resistance: Power Contacts—0.75 milliohms max.
Signal Contacts—15 milliohms max.
Insulation Resistance: 5000 Megohms min.

Mechanical

Mating Force: Single Power Contact—6.87N (1.54 lb.) Nom.
Single Signal Contact—1.08N (0.24 lb.) Nom.
Unmating Force:
Single Power Contact—5.88N (1.32 lb.) Nom.
Single Signal Contact—0.02N (0.03 lb.) Nom.
Durability: 250 Cycles

Physical

Housing: LCP, UL 94V-0
Contact: Copper Alloy
Plating: Contact Area—Select Gold
Solder Tail Area—Tin
Underplating—Nickel

No. of Signal Pins	Order No.				PC Tail Length	PCB Thickness	Lead-free
	No PCB Pegs or BMI Guides	BMI Guides, No PCB Pegs	PCB Pegs, No BMI Guides	PCB Pegs and BMI Guides			
0	45985-1911	45985-1912	45985-1913	45985-1914	4.50mm (.177")	3.18mm (.125")	
12	45985-1111	45985-1211	45985-1311	45985-1411			
16	45985-1121	45985-1221	45985-1321	45985-1421			
20	45985-1131	45985-1231	45985-1331	45985-1431			
24	45985-1141	45985-1241	45985-1341	45985-1441			
28	45985-1151	45985-1251	45985-1351	45985-1451			
32	45985-1161	45985-1261	45985-1361	45985-1461			
36	45985-1171	45985-1271	45985-1371	45985-1471			
40	45985-1181	45985-1281	45985-1381	45985-1481			
0	45985-1921	45985-1922	45985-1923	45985-1924			
12	45985-1112	45985-1212	45985-1312	45985-1412			
16	45985-1122	45985-1222	45985-1322	45985-1422			
20	45985-1132	45985-1232	45985-1332	45985-1432			
24	45985-1142	45985-1242	45985-1342	45985-1442			
28	45985-1152	45985-1252	45985-1352	45985-1452			
32	45985-1162	45985-1262	45985-1362	45985-1462			
36	45985-1172	45985-1272	45985-1372	45985-1472			
40	45985-1182	45985-1282	45985-1382	45985-1482			
0	45985-1931	45985-1932	45985-1933	45985-1934			
12	45985-1113	45985-1213	45985-1313	45985-1413			
16	45985-1123	45985-1223	45985-1323	45985-1423			
20	45985-1133	45985-1233	45985-1333	45985-1433			
24	45985-1143	45985-1243	45985-1343	45985-1443			
28	45985-1153	45985-1253	45985-1353	45985-1453			
32	45985-1163	45985-1263	45985-1363	45985-1463			
36	45985-1173	45985-1273	45985-1373	45985-1473			
40	45985-1183	45985-1283	45985-1383	45985-1483			

EXTreme LPHPower™ Low Profile Hybrid PCB Receptacle

46112/46113/46114

Vertical, with Press Fit PCB Tails

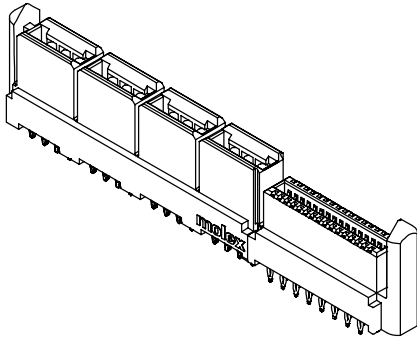

Features and Benefits

- Low Profile Hybrid (LPH) receptacle header combines mixed power and signal contacts for high current, right angle board-to-board applications
- Horizontal contact design provides low profile height for improved air flow

Reference Information

Product Specification: PS-46114-001

Packaging: Tube

UL File No.: E29179

Mates With: 45985 Headers or 1.57mm (.062") thick card edge

Designed In: Millimeters

Electrical

Voltage: 250V

Current: Power Contacts—30.0A max.

Signal Contacts—1.0A max.

Current Interruption: Power—30.0A at 42VDC

Signal—1.0A at 30V

Contact Resistance: Power Contacts—0.75 milliohms max.

Signal Contacts—15 milliohms max.

Insulation Resistance: 5000 Megohms min.

Mechanical

Mating Force: Single Power Contact—6.87N (1.54 lb.) Nom.

Single Signal Contact—1.08N (0.24 lb.) Nom.

Unmating Force:

Single Power Contact—5.88N (1.32 lb.) Nom.

Single Signal Contact—0.02N (0.03 lb.) Nom.

Durability: 250 Cycles

Physical

Housing: LCP, UL 94V-0

Contact: Copper Alloy

Plating: Contact Area—Select Gold

Solder Tail Area—Tin/Lead available upon request

Underplating—Nickel

Power Blades	Signal Pins	Without BMI Guides	With BMI Guides	Lead-free
0	12	46113-0121	46113-0123	Yes
	16	46113-0161	46113-0163	
	20	46113-0201	46113-0203	
	24	46113-0241	46113-0243	
	28	46113-0281	46113-0283	
	32	46113-0321	46113-0323	
	36	46113-0361	46113-0363	
	40	46113-0401	46113-0403	
2	0	46112-0201	46112-0203	Yes
	12	46114-2121	46114-2120	
	16	46114-2161	46114-2160	
	20	46114-2201	46114-2200	
	24	46114-2241	46114-2240	
	28	46114-2281	46114-2280	
	32	46114-2321	46114-2320	
	36	46114-2361	46114-2360	
4	0	46112-0401	46112-0403	Yes
	12	46114-4121	46114-4120	
	16	46114-4161	46114-4160	
	20	46114-4201	46114-4200	
	24	46114-4241	46114-4240	
	28	46114-4281	46114-4280	
	32	46114-4321	46114-4320	
	36	46114-4361	46114-4360	
6	0	46112-0601	46112-0603	Yes
	12	46114-6121	46114-6120	
	16	46114-6161	46114-6160	
	20	46114-6201	46114-6200	
	24	46114-6241	46114-6240	
	28	46114-6281	46114-6280	
	32	46114-6321	46114-6320	
	36	46114-6361	46114-6360	
40	46114-6401	46114-6400		

Power Blades	Signal Pins	Without BMI Guides	With BMI Guides	Lead-free
8	0	46112-0801	46112-0803	Yes
	12	46114-8121	46114-8120	
	16	46114-8161	46114-8160	
	20	46114-8201	46114-8200	
	24	46114-8241	46114-8240	
	28	46114-8281	46114-8280	
	32	46114-8321	46114-8320	
	36	46114-8361	46114-8360	
10	0	46112-1001	46112-1003	Yes
	12	46114-1013	46114-1012	
	16	46114-1017	46114-1016	
	20	46114-1021	46114-1020	
	24	46114-1025	46114-1024	
	28	46114-1029	46114-1028	
	32	46114-1033	46114-1032	
	36	46114-1037	46114-1036	
12	0	46112-1041	46112-1040	Yes
	12	46112-1201	46112-1203	
	16	46114-1213	46114-1212	
	16	46114-1217	46114-1216	
	20	46114-1221	46114-1220	
	24	46114-1225	46114-1224	
	28	46114-1229	46114-1228	
	32	46114-1233	46114-1232	
14	0	46112-1237	46114-1236	Yes
	40	46114-1241	46114-1240	
	0	46112-1401	46112-1403	
	12	46114-1413	46114-1412	
	16	46114-1417	46114-1416	
	20	46114-1421	46114-1420	
	24	46114-1425	46114-1424	
	28	46114-1429	46114-1428	
32	46114-1433	46114-1432		
14	36	46114-1437	46114-1436	Yes
	40	46114-1441	46114-1440	

EXTreme LPHPower™ Low Profile Hybrid PCB Receptacle

45984

Right Angle, Signal Only

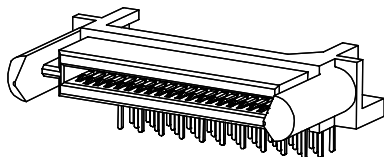

Features and Benefits

- Low Profile Hybrid (LPH) signal only receptacle header is designed for coplanar, board-to-board applications
- Horizontal contact design provides low profile height at only 7.49mm (.295") max. for improved air flow

Reference Information

Product Specification: PS-45984-001
 Packaging: Tray
 UL File No.: E29179
 Mates With: 45985 Headers or 1.57mm (.062") thick card edge
 Designed In: Millimeters

Electrical

Voltage: 250V
 Current: Signal Contacts—1.0A max.
 Current Interruption: Signal—1.0A at 30V
 Contact Resistance: Signal Contacts—15 milliohms max.
 Insulation Resistance: 5000 Megohms min.

Mechanical

Mating Force: Single Signal Contact—1.08N (0.24 lb.) Nom.
 Unmating Force:
 Single Signal Contact—0.02N (0.03 lb.) Nom.
 Durability: 250 Cycles

Physical

Housing: LCP, UL 94V-0
 Contact: Copper Alloy
 Plating: Contact Area—Select Gold
 Solder Tail Area—Tin
 Underplating—Nickel

No. of Signal Pins	Order No.				PC Tail Length	PCB Thickness	Lead-free			
	No PCB Pegs or BMI Guides	BMI Guides, No PCB Pegs	PCB Pegs, No BMI Guides	PCB Pegs and BMI Guides						
12	45984-0111	45984-0211	45984-0311	45984-0411	4.50mm (.177")	3.18mm (.125")				
16	45984-0121	45984-0221	45984-0321	45984-0421						
20	45984-0131	45984-0231	45984-0331	45984-0431						
24	45984-0141	45984-0241	45984-0341	45984-0441						
28	45984-0151	45984-0251	45984-0351	45984-0451						
32	45984-0161	45984-0261	45984-0361	45984-0461						
36	45984-0171	45984-0271	45984-0371	45984-0471						
40	45984-0181	45984-0281	45984-0381	45984-0481						
12	45984-0112	45984-0212	45984-0312	45984-0412				3.60mm (.143")	2.36mm (.093")	Yes
16	45984-0122	45984-0222	45984-0322	45984-0422						
20	45984-0132	45984-0232	45984-0332	45984-0432						
24	45984-0142	45984-0242	45984-0342	45984-0442						
28	45984-0152	45984-0252	45984-0352	45984-0452						
32	45984-0162	45984-0262	45984-0362	45984-0462						
36	45984-0172	45984-0272	45984-0372	45984-0472						
40	45984-0182	45984-0282	45984-0382	45984-0482						
12	45984-0113	45984-0213	45984-0313	45984-0413	2.90mm (.114")	1.57mm (.062")				
16	45984-0123	45984-0223	45984-0323	45984-0423						
20	45984-0133	45984-0233	45984-0333	45984-0433						
24	45984-0143	45984-0243	45984-0343	45984-0443						
28	45984-0153	45984-0253	45984-0353	45984-0453						
32	45984-0163	45984-0263	45984-0363	45984-0463						
36	45984-0173	45984-0273	45984-0373	45984-0473						
40	45984-0183	45984-0283	45984-0383	45984-0483						

EXTreme LPHPower™ Low Profile Hybrid PCB Header

45984

Right Angle, Signal Only

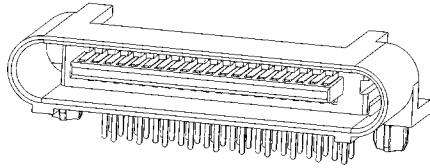

Features and Benefits

- Low Profile Hybrid (LPH) signal only header is designed for coplanar, board-to-board applications
- Horizontal contact design provides low profile height at only 7.49mm (.295") max. for improved air flow

Reference Information

Product Specification: PS-45984-001
 Packaging: Tray
 UL File No.: E29179
 Mates With: 45984 signal only receptacles
 Designed In: Millimeters

Electrical

Voltage: 250V
 Current: Signal Contacts—1.0A max.
 Current Interruption: Signal—1.0A at 30V
 Contact Resistance: Signal Contacts—15 milliohms max.
 Insulation Resistance: 5000 Megohms min.

Mechanical

Mating Force: Single Signal Contact—1.08N (0.24 lb.) Nom.
 Unmating Force:
 Single Signal Contact—0.02N (0.03 lb.) Nom.
 Durability: 250 Cycles

Physical

Housing: LCP, UL 94V-0
 Contact: Copper Alloy
 Plating: Contact Area—Select Gold
 Solder Tail Area—Tin
 Underplating—Nickel

No. of Signal Pins	Order No.				PC Tail Length	PCB Thickness	Lead-free		
	No PCB Pegs or BMI Guides	BMI Guides, No PCB Pegs	PCB Pegs, No BMI Guides	PCB Pegs and BMI Guides					
12	45985-0111	45985-0211	45985-0311	45985-0411	4.50mm (.177")	3.18mm (.125")			
16	45985-0121	45985-0221	45985-0321	45985-0421					
20	45985-0131	45985-0231	45985-0331	45985-0431					
24	45985-0141	45985-0241	45985-0341	45985-0441					
28	45985-0151	45985-0251	45985-0351	45985-0451					
32	45985-0161	45985-0261	45985-0361	45985-0461					
36	45985-0171	45985-0271	45985-0371	45985-0471					
40	45985-0181	45985-0281	45985-0381	45985-0481					
12	45985-0112	45985-0212	45985-0312	45985-0412				3.60mm (.143")	2.36mm (.093")
16	45985-0122	45985-0222	45985-0322	45985-0422					
20	45985-0132	45985-0232	45985-0332	45985-0432					
24	45985-0142	45985-0242	45985-0342	45985-0442					
28	45985-0152	45985-0252	45985-0352	45985-0452					
32	45985-0162	45985-0262	45985-0362	45985-0462					
36	45985-0172	45985-0272	45985-0372	45985-0472					
40	45985-0182	45985-0282	45985-0382	45985-0482					
12	45985-0113	45985-0213	45985-0313	45985-0413	2.90mm (.114")	1.57mm (.062")			
16	45985-0123	45985-0223	45985-0323	45985-0423					
20	45985-0133	45985-0233	45985-0333	45985-0433					
24	45985-0143	45985-0243	45985-0343	45985-0443					
28	45985-0153	45985-0253	45985-0353	45985-0453					
32	45985-0163	45985-0263	45985-0363	45985-0463					
36	45985-0173	45985-0273	45985-0373	45985-0473					
40	45985-0183	45985-0283	45985-0383	45985-0483					

E

Power Connectors

5.50 (DC) or 7.50mm (AC) Pitch Power 2.54 by 2.54mm Pitch Signal EXTreme Ten60Power™ Board-to-Board High Current Connector

46437

Plug

46436

Right Angle Receptacle

46562

Vertical Receptacle

Ten60 is a custom configurable connector system featuring a module design giving it the flexibility to provide virtually any arrangement of AC Power, DC Power, and signal lines all with three levels of mating. Modules are available in 1-10 DC power blades, 1-6 AC Power Blades, and 6-36 Signal Pins. Modules can be arranged in any combination.

Features and Benefits

- Low-profile design: 10.00mm (.394") height enhances system airflow and provides 260.0A per linear inch
- Robust, high-current contact blades in DC and AC spacing options provides design flexibility
- Multiple mating levels available on power and signal contacts for hot-plug applications
- Module assembly allows for any configuration and can be added to make larger circuit sizes
- Right-angle and vertical mounting available for either coplanar or perpendicular applications
- RoHS compliant

Reference Information

Product Specification: PS-46436-100
Packaging: Tray
UL File No.: E29179
CSA File No.: LR-19980
TUV File No.: R 72081037
Designed In: Millimeters

Electrical

Voltage: Power—600V max.
Signal—250V max.
Current: Power—60.0A max.
Signal—2.5A max.
Dielectric Withstanding Voltage: 1500V
Insulation Resistance: 5000 Megohms min.

Mechanical

Mating Force:
Power Contacts—
Vertical Receptacle: 764g (1.684 lb) max.
Right Angle Receptacle: 460g (1.014 lb) max.
Signal Contacts—75g (.165 lb)
Unmating Force:
Power Contacts—
Vertical Receptacle: 340g (.749 lb) max.
Right Angle Receptacle: 235g (.518 lb) max.
Signal Contacts—30g (.066 lb)
Durability: 100 cycles

Physical

Housing: 30% glass-filled LCP, UL 94V-0
Contact: Power Contacts—Copper Alloy
Signal Contacts—Copper Alloy
Plating: Contact Area—Select Gold
Solder Tail Area—Tin
Underplating—Nickel

SELECTION GUIDE

Connector Orientation	- Vertical - Right Angle
Termination Method	- Through Hole - Press-Fit - Power-Signal-Power (P-S-P) - Power-Signal (P-S)
Type*	- Power-Signal (P-S) - Power-Signal-Power (Top Guides) (P-S-P (TG)) - Power-Signal-AC Power (P-S-AC) - AC Power-Signal-Power (AC-S-P)
Power and Signal	- Number of DC Power Blades (Example: 2 DC power blades = 2 P) - Number of AC Power Blades (Example: 2 AC power blades = 2 AC) - Number of Signal Pins (Example: 24 signal pins = 24 S)
Guide Post and Board Pegs	- With Guide Post and Pegs - Without Guide Post and Pegs
Pitch	- DC Power: 5.50mm (0.217") Pitch - AC Power: 7.50mm (0.295") Pitch

* For additional Configurations not shown contact Molex

EXTreme Ten60Power™ High Current Connectors

Power-Signal (P-S)

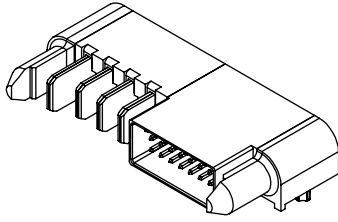

46437
Right Angle,
Through Hole Header

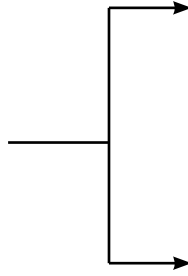

46436
Right Angle,
Through Hole Receptacle

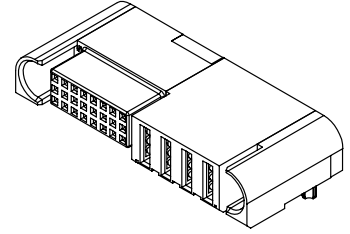

46562
Vertical,
Press-Fit Receptacle

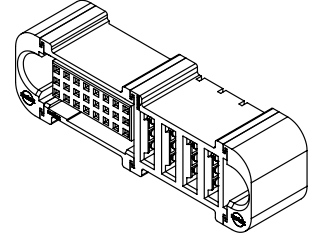

E

Power Connectors

Signal-Power (S-P)

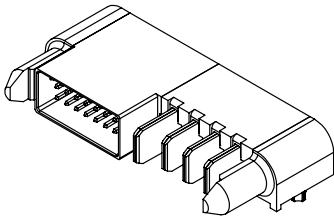

46437
Right Angle,
Through Hole Header

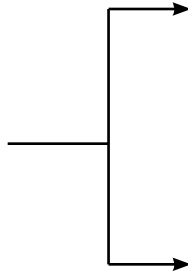

46436
Right Angle,
Through Hole Receptacle

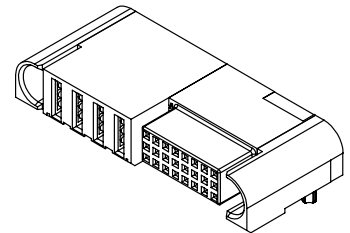

46562
Vertical,
Press-Fit Receptacle

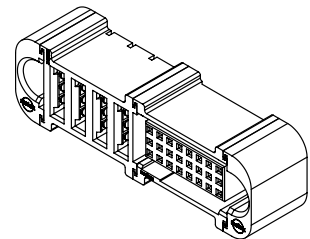

EXTreme Ten60Power™ High Current Connectors

Power-Signal-Power (P-S-P)

E

Power Connectors

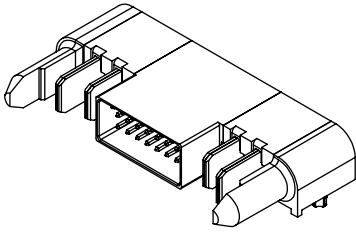

46437
Right Angle,
Through Hole Header

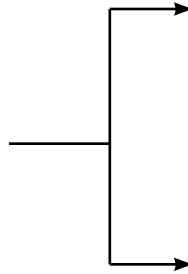

46436
Right Angle,
Through Hole Receptacle

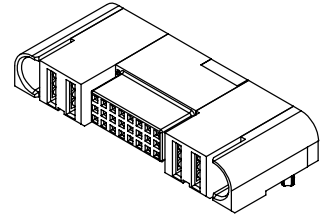

46562
Vertical,
Press-Fit Receptacle

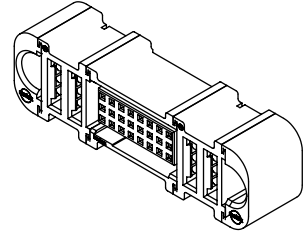

Power-Signal-Power with Top Guides (P-S-P (TG))

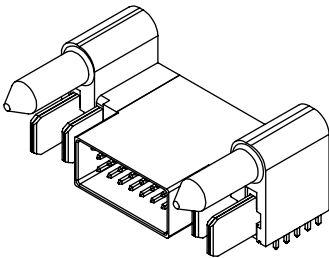

46437
Right Angle,
Through Hole Header

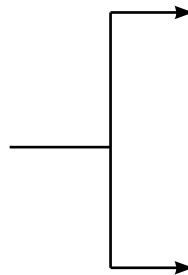

46436
Right Angle,
Through Hole Receptacle

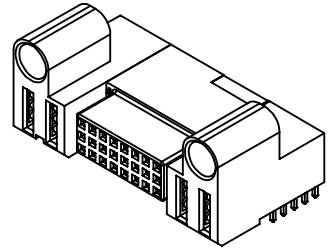

46562
Vertical,
Press-Fit Receptacle

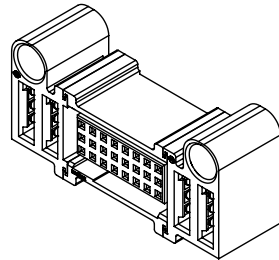

EXTreme Ten60Power High Current Connectors

Power-Signal-AC Power (P-S-AC)

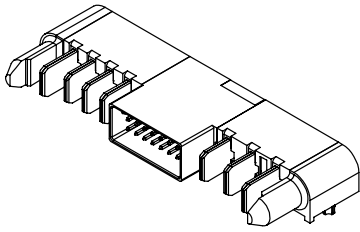

46437
Right Angle,
Through Hole Header

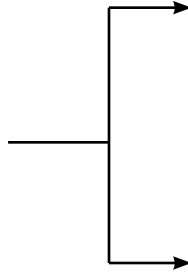

46436
Right Angle,
Through Hole Receptacle

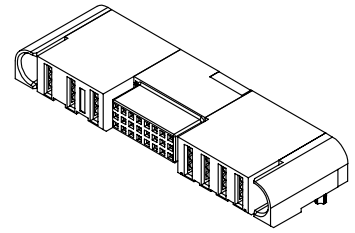

46562
Vertical,
Press-Fit Receptacle

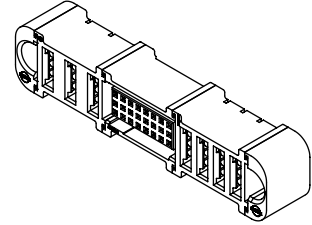

AC Power-Signal-Power (AC-S-P)

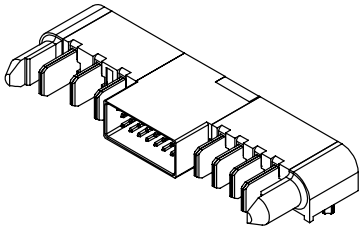

46437
Right Angle,
Through Hole Header

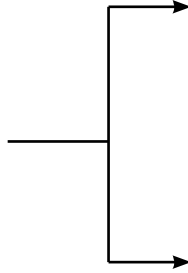

46436
Right Angle,
Through Hole Receptacle

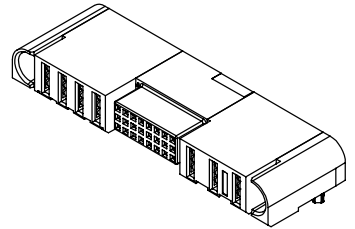

46562
Vertical,
Press-Fit Receptacle

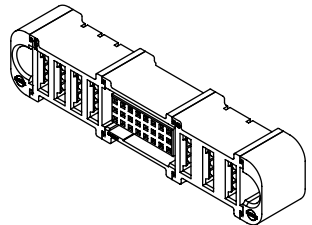

EXTreme PowerEdge™ Card Edge or Bus Bar Connector

45714/45719

High Current Contacts

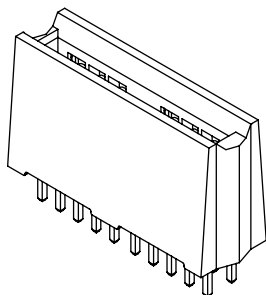

Features and Benefits

- High current, up to 40.0A per contact
- Rated for current interruption
- Press-fit or solder terminations
- Available in 2, 3 or 4 segments
- End-to-end stackable

Reference Information

Product Specification: PS-45719-001
 Packaging: Tray
 UL File No.: E29179
 CSA File No.: LR19980
 TUV File No.: R72042763
 Mates With: 1.58mm (.062") thick card edge or bus bar
 Stackable With: 45844, 45845, 45911 or 45912
 Designed In: Millimeters

Electrical

Voltage: 250V
 Current: 40.0A max.
 Contact Resistance: 1 milliohm max.
 Dielectric Withstanding Voltage: 1500V
 Insulation Resistance: 5000 Megohms min.

Mechanical

Mating Force: 8.8N Typ.
 Unmating Force: 4.4N Typ.
 Durability: 250 Cycles

Physical

Housing: Glass-filled LCP, UL 94V-0
 Contact: Copper Alloy
 Plating: Contact Area—Select Gold
 Solder or Press-fit Tail Area—Tin
 Underplating—Nickel
 PCB Thickness: Series 45714—2.36mm (.093") or greater;
 Series 45719—Separate parts available for 1.57mm (.062") max., 2.36mm (.093") max or 3.18mm (.125") max.

Through Hole Solder PCB Termination				
Order No.	Segments	Total Contacts	Max. PCB Thickness	Lead-free
45719-0001	2	4	3.18mm (.125")	Yes
45719-0002	3	6		
45719-0003	4	8		
45719-0004	2	4	2.36mm (.093")	
45719-0005	3	6		
45719-0006	4	8		
45719-0007	2	4	1.57mm (.062")	
45719-0008	3	6		
45719-0009	4	8		

Press-fit PCB Termination			
Order No.	Segments	Total Contacts	Lead-free
45714-0001	2	4	Yes
45714-0002	3	6	
45714-0003	4	8	

EXTreme PowerEdge™ Card Edge or Bus Bar Connector

45844/45845

Signal Contacts

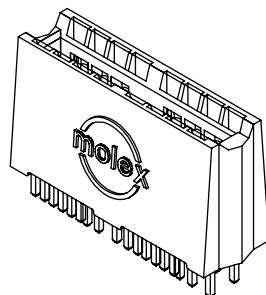

Features and Benefits

- For slow speed signal applications
- Press-fit or solder terminations
- Available in 2, 3 or 4 segments
- End-to-end stackable

Reference Information

Product Specification: PS-45844-001
 Packaging: Tray
 UL File No.: E29179
 CSA File No.: LR19980
 TUV File No.: R72042763
 Mates With: 1.58mm (.062") thick card edge or bus bar
 Stackable With: 45845, 45844, 45911 and 45912
 Designed In: Millimeters

Electrical

Voltage: 250V
 Current: 3.0A max.
 Contact Resistance: 15 milliohms max.
 Dielectric Withstanding Voltage: 1500V
 Insulation Resistance: 5000 Megohms min.

Mechanical

Mating Force: 1.4N Typ.
 Unmating Force: 0.14N Typ.
 Durability: 250 Cycles

Physical

Housing: Glass-filled LCP, UL 94V-0
 Contact: Copper Alloy
 Plating: Contact Area—Select Gold
 Solder or Press-fit Tail Area—Tin
 Underplating—Nickel
 PCB Thickness: Series 45844—Separate parts available for 1.57mm (.062") max. or 3.18mm (.125") max.;
 Series 45845—2.36mm (.093") or greater

Through Hole Solder PCB Termination				
Order No.	Segments	Total Contacts	Max. PCB Thickness	Lead-free
45844-0001	2	16	3.18mm (.125")	Yes
45844-0002	3	24		
45844-0003	4	32		
45844-0004	2	16	1.57mm (.062")	
45844-0005	3	24		
45844-0006	4	32		

Press-fit PCB Termination			
Order No.	Segments	Total Contacts	Lead-free
45845-0001	2	16	Yes
45845-0002	3	24	
45845-0003	4	32	

EXTreme PowerEdge™ Card Edge or Bus Bar Connector

45911

Mixed High Current and Signal Contacts, Through-Hole Solder PCB Termination

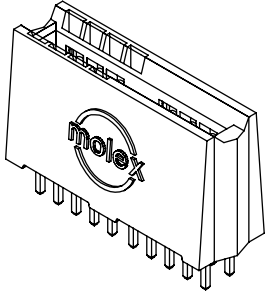

Features and Benefits

- High current, up to 40.0A per contact
- Power and signal contacts in same connector
- Rated for current interruption
- Available in 2, 3 or 4 segments
- End-to-end stackable

Reference Information

Product Specification: PS-45719-001
 Packaging: Tray
 UL File No.: E29179
 CSA File No.: LR19980
 TUV File No.: R72042763
 Mates With: 1.58mm (.062") thick card edge or bus bar
 Stackable With: 45719 and 45844
 Designed In: Millimeters

Electrical

Voltage: 250V
 Current: Power Contacts—40.0A max.
 Signal Contacts—3.0A max.
 Contact Resistance: Power Contacts—1 milliohm max.
 Signal Contacts—15 milliohms max.
 Dielectric Withstanding Voltage: 1500V
 Insulation Resistance: 5000 Megohms min.

Mechanical

Mating Force: Power Contacts—8.8N Typ.
 Signal Contacts—1.4N Typ.
 Unmating Force: Power Contacts—4.4N Typ.
 Signal Contacts—0.14N Typ.
 Durability: 250 Cycles

Physical

Housing: Glass-filled LCP, UL 94V-0
 Contact: Copper Alloy
 Plating: Contact Area—Select Gold
 Solder Tail Area—Tin
 Underplating—Nickel
 PCB Thickness: Separate parts available for 1.57mm (.062")
 max. or 3.18mm (.125") max.

E

Power Connectors

Order No.	Segments	Segment Sequence*	Total Contacts*	Max. PCB Thickness	Lead-free	Order No.	Segments	Segment Sequence*	Total Contacts*	Max. PCB Thickness	Lead-free
45911-0001	2	P, S	2 P, 8 S	3.18mm (.125")	Yes	45911-0031	4	P, S, S, S	2 P, 24 S	3.18mm (.125")	Yes
45911-0002		S, P		4 P, 16 S							
45911-0003		P, S		2 P, 24 S							
45911-0004		S, P									
45911-0007	3	P, P, S	4 P, 8 S	3.18mm (.125")		45911-0034		S, P, S, S	2 P, 24 S		
45911-0008		P, S, P				4 P, 16 S					
45911-0009		P, S, S	4 P, 8 S					1.57mm (.062")	45911-0035		
45911-0010		S, P, S				4 P, 16 S			45911-0036		
45911-0011		S, S, P	4 P, 8 S	45911-0037					S, S, P, P	4 P, 16 S	
45911-0012		S, P, P		4 P, 8 S		45911-0038			S, P, P, P		
45911-0013		P, P, S	2 P, 16 S			45911-0039		P, P, P, S	6 P, 8 S		
45911-0014		P, S, P		4 P, 8 S		45911-0040		P, P, S, P			
45911-0015		P, S, S	2 P, 16 S			3.18mm (.125")		45911-0041	P, P, S, S	1.57mm (.062")	
45911-0016		S, P, S		4 P, 8 S				45911-0042	P, S, P, S		
45911-0017		S, S, P	4 P, 8 S		45911-0043		P, S, S, P				
45911-0018		S, P, P		6 P, 8 S	45911-0044		P, S, P, P	6 P, 8 S			
45911-0025	P, P, P, S	4 P, 16 S	45911-0045		P, S, S, S	2 P, 24 S					
45911-0026	P, P, S, P		4 P, 16 S	45911-0046	S, P, P, S		4 P, 16 S				
45911-0027	P, P, S, S	6 P, 8 S		45911-0047	S, P, S, P	2 P, 24 S					
45911-0028	P, S, P, S		4 P, 16 S	45911-0048	S, S, P, S						
45911-0029	P, S, S, P	6 P, 8 S		45911-0049	S, S, S, P	4 P, 16 S					
45911-0030	P, S, P, P		6 P, 8 S	45911-0050	S, S, P, P						
							45911-0051		S, S, P, P	4 P, 16 S	
						45911-0052		S, P, P, P	6 P, 8 S		

*P = Power, S = Signal

EXTreme PowerEdge™ Card Edge or Bus Bar Connector

45912

Mixed High Current and Signal Contacts, Press-fit PCB Termination

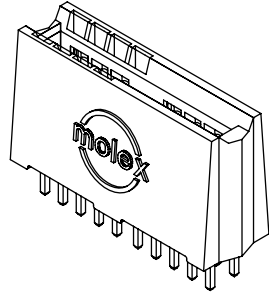

Features and Benefits

- High current, up to 40.0A per contact
- Power and signal contacts in same connector
- Rated for current interruption
- Available in 2, 3 or 4 segments
- End-to-end stackable

Reference Information

Product Specification: PS-45719-001
 Packaging: Tray
 UL File No.: E29179
 CSA File No.: LR19980
 TUV File No.: R72042763
 Mates With: 1.58mm (.062") thick card edge or bus bar
 Stackable With: 45714 and 45845
 Designed In: Millimeters

Electrical

Voltage: 250V
 Current: Power Contacts—40.0A max.
 Signal Contacts—3.0A max.
 Contact Resistance: Power Contacts—1 milliohm max.
 Signal Contacts—15 milliohms max.
 Dielectric Withstanding Voltage: 1500V
 Insulation Resistance: 5000 Megohms min.

Mechanical

Mating Force: Power Contacts—8.8N Typ.
 Signal Contacts—1.4N Typ.
 Unmating Force: Power Contacts—4.4N Typ.
 Signal Contacts—0.14N Typ.
 Durability: 250 Cycles

Physical

Housing: Glass-filled LCP, UL 94V-0
 Contact: Copper Alloy
 Plating: Contact Area—Select Gold
 Press-fit Tail Area—Tin
 Underplating—Nickel
 PCB Thickness: 2.36mm (.093") or greater

E

Power Connectors

Order No.	Segments	Segment Sequence*	Total Contacts*	Lead-free
45912-0001	2	P, S	2 P, 8 S	Yes
45912-0002		S, P		
45912-0007	3	P, P, S	4 P, 8 S	
45912-0008		P, S, P		
45912-0009		P, S, S	2 P, 16 S	
45912-0010		S, P, S		
45912-0011	S, S, P	4 P, 8 S		
45912-0012	S, P, P			
45912-0025	4	P, P, P, S	6 P, 8 S	
45912-0026		P, P, S, S	4 P, 16 S	
45912-0027				

*P = Power, S = Signal

Order No.	Segments	Segment Sequence*	Total Contacts*	Lead-free
45912-0028	4	P, S, P, S	4 P, 16 S	Yes
45912-0029		P, S, S, P		
45912-0030		P, S, P, P	6 P, 8 S	
45912-0031		P, S, S, S	2 P, 24 S	
45912-0032		S, P, P, S	4 P, 16 S	
45912-0033		S, P, S, P		
45912-0034		S, P, S, S	2 P, 24 S	
45912-0035		S, S, P, S		
45912-0036		S, S, S, P	4 P, 16 S	
45912-0037		S, S, P, P		
45912-0038		S, P, P, P	2 P, 24 S	

10.00mm (.393") Pitch Mini-Fit Sr.™

- Wire-to-Wire (free hanging and panel mount)
- Wire-to-Board
- Mandatory Terminal Position Assurance (TPA) Piece

- Voltage: 600V
- Current: 50.0A max.*

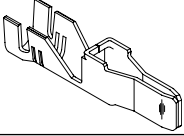
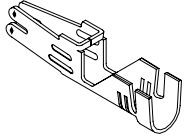
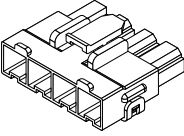
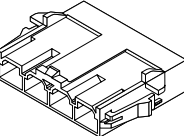
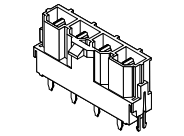
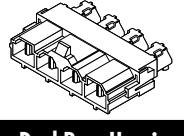
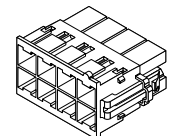
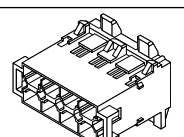
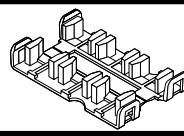
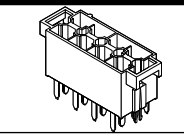
	Series	Description	Mates With/ Use With	Material	Circuits/ Wire Gauge	Features and Benefits
Terminals						
	42817	Male Terminal	Mates with 42815 Terminal Used in 42818 and 43938 Housings	Tin or Select Gold-plated Copper Alloy	8 to 16 AWG	<ul style="list-style-type: none"> • Mating Cycles—Tin: 30/Gold: 100 • Four points of electrical contact provide high reliability • Low insertion force design for greater ease in assembly
	42815	Female Terminal	Mates with 42817 Terminal and PCB Header Terminal Used in 42816 and 43914 Housings			
Single Row Housings						
	42816	Receptacle Housing	Mates with 42818, 42819, 42820	Black Polyester, UL 94V-0	2, 3, 4, 5 and 6 Circuits	<ul style="list-style-type: none"> • TPA (Terminal Position Assurance) piece attached to housing to prevent terminal backouts • Positive latch guards against accidental disengagement of housings • Polarized housing helps prevent improper mating • Used in wire-to-wire and wire-to-board applications
	42818	Plug Housing	Mates with 42816			
Single Row PC Board Headers						
	42819	Vertical Header	Mates with 42816	Housings: Black Glass-filled 4/6 Nylon, UL 94V-0 Terminals: Tin or Select Gold-plated Copper Alloy	2, 3, 4, 5 and 6 Circuits	<ul style="list-style-type: none"> • Metal forklocks for secure retention to PC board • Accommodates 1.57, 2.36, 3.18 and 6.35mm (.062, .093, .125 and .250") thick PC Boards
	42820	Right Angle Header				
Dual Row Housings						
	43914	Receptacle Housing	Mates with 43938, 43915 Use with 43980	Black Polyester, UL 94V-0	6, 8, 10, 12 and 14 Circuits	<ul style="list-style-type: none"> • Mandatory TPA (Terminal Position Assurance) piece (43980 series) sold separately • Positive latch guards against accidental disengagement of housings • Polarized housing helps prevent improper mating • Used in wire-to-wire or wire-to-board applications
	43938	Plug Housing	Mates with 43914 Use with 43980			
Dual Row TPA (Terminal Position Assurance Piece)						
	43980	TPA	Must Use With 43914, 43938	White Polyester, UL 94V-0	6, 8, 10, 12 and 14 Circuits	<ul style="list-style-type: none"> • Virtually eliminates terminal back out • White color for easy activation identification
Dual Row Vertical PC Board Header						
	43915	Vertical Header	Mates with 43914	Housing: Black Glass-filled 4/6 Nylon, UL 94V-0 Terminals: Tin or Select Gold-plated Copper Alloy	6, 8, 10, 12 and 14 Circuits	<ul style="list-style-type: none"> • Metal forklocks for secure retention to PC board • Accommodates 1.57, 2.36, 3.18 and 6.35mm (.062, .093, .125 and .250")

*Maximum current is dependent on wire gauge and circuit size. See Mini-Fit, Sr. product specification PS-42815-001.

10.00mm (.393") Pitch Mini-Fit Sr.™ Terminal

42815
Female

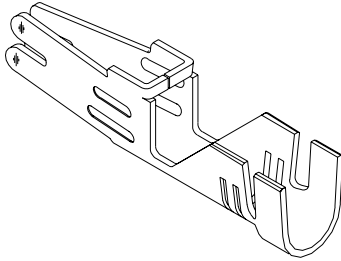

Features and Benefits

- High current
- Low engagement force
- Wire-to-wire, wire-to-board
- Four points of electrical contact

Reference Information

Product Specification: PS-42815-0001
 Packaging: Reel
 UL File No.: E29179
 CSA File No.: LR19980
 TUV License No.: R9751144
 Use With: 42816 and 43914 receptacle housings
 Designed In: Millimeters

Electrical

Voltage: 600V
 Current: 50.0A max.*
 Contact Resistance: 1.5 milliohms max.
 Dielectric Withstanding Voltage: 2200V
 Insulation Resistance: 1000 Megohms min.

Mechanical

Contact Insertion Force: 29.4N max.
 Contact Retention to Housing: 98.1N min.
 Mating Force: 29.4N max.
 Unmating Force: 4.9N min.
 Normal Force: 1.96N min.
 Durability: Tin—30 cycles; Gold—100 cycles

Physical

Contact: Copper Alloy
 Plating: Tin or Select Gold
 Wire gauge: 8, 10, 12, 14, 16 AWG

* Depending on circuit size, wire gauge and PCB. Please refer to product specification.

Order No.	Plating*	Wire Size (AWG)	Lead-free
42815-0041	Tin	14-16	Yes
42815-0042	Select Gold		
42815-0011	Tin	10-12	
42815-0012	Select Gold		
42815-0031	Tin	8	
42815-0032	Select Gold		

* Select Gold plated terminals recommended. See product specification for additional information.

10.00mm (.393") Pitch Mini-Fit Sr.™ Terminal

42817
Male

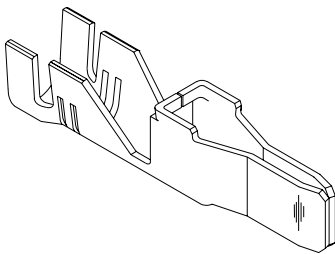

Features and Benefits

- High current
- Four points of electrical contact
- Low engagement force
- Wire-to-wire
- Grounding contacts available

Reference Information

Product Specification: PS-42815-0001
 Packaging: Reel
 UL File No.: E29179
 CSA File No.: LR19980
 TUV License No.: R9751144
 Use With: 42818 and 43938 plug housings
 Designed In: Millimeters

Electrical

Voltage: 600V
 Current: 50.0A max.*
 Contact Resistance: 1.5 milliohms max.
 Dielectric Withstanding Voltage: 2200V
 Insulation Resistance: 1000 Megohms min.

Mechanical

Contact Insertion Force: 29.4N max.
 Contact Retention to Housing: 98.1N min.
 Mating Force: 29.4N max.
 Unmating Force: 4.9N min.
 Normal Force: 1.96N min.
 Durability: Tin—30 cycles; Select Gold—100 cycles

Physical

Contact: Copper Alloy
 Plating: Tin or Select Gold
 Wire gauge: 8, 10, 12, 14 and 16 AWG

* Depending on circuit size and wire gauge. Please refer to product specification.

Standard Contacts			
Order No.	Plating*	Wire Gauge	Lead-free
42817-0041	Tin	14-16	Yes
42817-0042	Select Gold		
42817-0011	Tin	10-12	
42817-0012	Select Gold		
42817-0031	Tin	8	
42817-0032	Select Gold		

* Select Gold plated terminals recommended. See product specification for additional information.

Grounding Contacts			
Order No.	Plating*	Wire Gauge	Lead-free
42817-0141	Tin	14-16	Yes
42817-0142	Select Gold		
42817-0111	Tin	10-12	
42817-0112	Select Gold		
42817-0131	Tin	8	
42817-0132	Select Gold		

10.00mm (.393") Pitch Mini-Fit Sr.™ Receptacle Housing

42816
Single Row

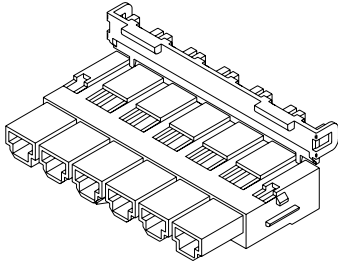

Circuits	Order No.
2	42816-0212
3	42816-0312
4	42816-0412
5	42816-0512
6	42816-0612

Features and Benefits

- High current
- Fully polarized
- Positive locks
- Low engagement force
- Wire-to-wire, wire-to-board
- Includes mandatory Terminal Position Assurance (TPA) clip

Reference Information

Product Specification: PS-42815-0001
 Packaging: Bag
 UL File No.: E29179
 CSA File No.: LR19980
 TUV License No.: R9751144
 Mates With: 42818 plug housing, 42819 and 42820 headers
 Use With: 42815 female terminal
 Designed In: Millimeters

Electrical

Voltage: 600V
 Current: 50.0A max.*
 Insulation Resistance: 1000 Megohms min.

Mechanical

Contact Insertion Force: 29.4N max.
 Contact Retention to Housing: 98.1N min.

Physical

Housing: Polyester, UL 94V-0

* Depending on circuit size, wire gauge and PCB. Please refer to product specification.

10.00mm (.393") Pitch Mini-Fit Sr.™ Plug Housing

42818
Panel Mount
Single Row

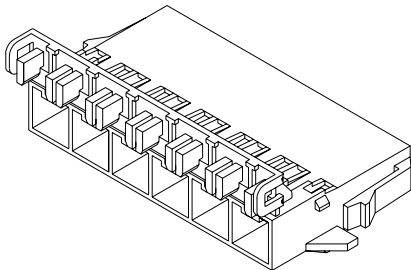

Circuits	Order No.
2	42818-0212
3	42818-0312
4	42818-0412
5	42818-0512
6	42818-0612

Features and Benefits

- High current
- Fully polarized
- Positive locks
- Low engagement force
- Wire-to-wire
- Panel Mountable
- Includes mandatory Terminal Position Assurance (TPA) clip

Reference Information

Product Specification: PS-42815-001
 Packaging: Bag
 UL File No.: E29179
 CSA File No.: LR19980
 TUV License No.: R9751144
 Mates With: 42816 receptacle housing
 Use With: 42817 male terminal
 Designed In: Millimeters

Electrical

Voltage: 600V
 Current: 50.0A max.*
 Insulation Resistance: 1000 Megohms min.

Mechanical

Contact Insertion Force: 29.4N max.
 Contact Retention to Housing: 98.1N min.

Physical

Housing: Polyester, UL 94V-0

* Depending on circuit size and wire gauge. Please refer to product specification.

10.00mm (.393") Pitch Mini-Fit Sr.™ Header

42819

**Vertical, Single Row
Metal Clip Mount**

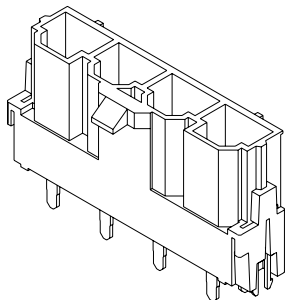

Features and Benefits

- High current
- Fully polarized
- Positive locks
- Low engagement force
- Wire-to-board
- Metal board retention clip

Reference Information

Product Specification: PS-42815-0001
Packaging: Tray
UL File No.: E29179
CSA File No.: LR19980
TUV License No.: R9751144
Mates With: 42816 receptacle housing
Designed In: Millimeters

Electrical

Voltage: 600V
Current: 48.0A max.*
Contact Resistance: 1.5 milliohms max.
Dielectric Withstanding Voltage: 2200V
Insulation Resistance: 1000 Megohms min.

Mechanical

Insertion Force to PCB: 19.6N max.
Normal Force: 1.96N min.
Durability: Tin—30 cycles; Gold—100 cycles

Physical

Housing: Glass-filled, 4/6 nylon, UL 94V-0
Contact: Copper Alloy
Plating: Tin or Select Gold
PCB Thickness: 1.57, 2.36, 3.17, or 6.35mm
(.062, .093, .125, or .250")

* Depending on circuit size, wire gauge and PCB. Please refer to product specification.

Circuits	Order No.		PCB Thickness	Retention Clip Length	PC Tail Length	Lead-free
	Tin*	Select Gold				
2	42819-2212	42819-2213	1.57 (.062)	1.80 (.070)	3.50 (.137)	Yes
	42819-2222	42819-2223	2.36 (.093)	2.60 (.102)	5.10 (.200)	
	42819-2232	42819-2233	3.18 (.125)	3.40 (.133)	8.30 (.327)	
	42819-2242	42819-2243	6.35 (.250)	6.58 (.259)	3.50 (.137)	
3	42819-3212	42819-3213	1.57 (.062)	1.80 (.070)	3.50 (.137)	
	42819-3222	42819-3223	2.36 (.093)	2.60 (.102)	5.10 (.200)	
	42819-3232	42819-3233	3.18 (.125)	3.40 (.133)	8.30 (.327)	
4	42819-4212	42819-4213	1.57 (.062)	1.80 (.070)	3.50 (.137)	
	42819-4222	42819-4223	2.36 (.093)	2.60 (.102)	5.10 (.200)	
	42819-4232	42819-4233	3.18 (.125)	3.40 (.133)	8.30 (.327)	
5	42819-5212	42819-5213	1.57 (.062)	1.80 (.070)	3.50 (.137)	
	42819-5222	42819-5223	2.36 (.093)	2.60 (.102)	5.10 (.200)	
	42819-5232	42819-5233	3.18 (.125)	3.40 (.133)	8.30 (.327)	
6	42819-6212	42819-6213	1.57 (.062)	1.80 (.070)	3.50 (.137)	
	42819-6222	42819-6223	2.36 (.093)	2.60 (.102)	5.10 (.200)	
	42819-6232	42819-6233	3.18 (.125)	3.40 (.133)	8.30 (.327)	
	42819-6242	42819-6243	6.35 (.250)	6.58 (.259)	8.30 (.327)	

* Select Gold headers recommended. See product specification for additional information.

10.00mm (.393") Pitch Mini-Fit Sr.™ Header

42820

**Right Angle, Single Row
Metal Clip Mount**

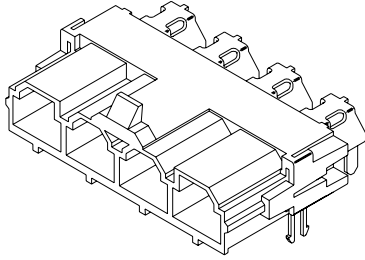

Features and Benefits

- High current
- Fully polarized
- Positive locks
- Low engagement force
- Wire-to-board
- Metal board retention clip

Reference Information

Product Specification: PS-42815-0001
Packaging: Tray
UL File No.: E29179
CSA File No.: LR19980
TUV License No.: R9751144
Mates With: 42816 receptacle housing
Designed In: Millimeters

Electrical

Voltage: 600V
Current: 48.0A max.*
Contact Resistance: 1.5 milliohms max.
Dielectric Withstanding Voltage: 2200V
Insulation Resistance: 1000 Megohms min.

Mechanical

Insertion Force to PCB: 19.6N max.
Normal Force: 1.96N min.
Durability: 30 cycles

Physical

Housing: Glass-filled, 4/6 nylon, UL 94V-0
Contact: Copper Alloy
Plating: Tin or Select Gold
PCB Thickness: 1.57, 2.36, 3.18, or 6.35mm
(.062, .093, .125, or .250")

* Depending on circuit size, wire gauge and PCB. Please refer to product specification.

Circuits	Order No.		PCB Thickness	Retention Clip Length	PC Tail Length	Lead-free
	Tin*	Select Gold				
2	42820-2212	42820-2213	1.57 (.062)	1.80 (.070)	3.50 (.137)	Yes
	42820-2222	42820-2223	2.36 (.093)	2.60 (.102)	5.10 (.200)	
	42820-2232	42820-2233	3.18 (.125)	3.40 (.133)		
	42820-2242	42820-2243	6.35 (.250)	6.58 (.259)	8.30 (.327)	
3	42820-3212	42820-3213	1.57 (.062)	1.80 (.070)	3.50 (.137)	
	42820-3222	42820-3223	2.36 (.093)	2.60 (.102)	5.10 (.200)	
	42820-3232	42820-3233	3.18 (.125)	3.40 (.133)		
	42820-3242	42820-3243	6.35 (.250)	6.58 (.259)	8.30 (.327)	
4	42820-4212	42820-4213	1.57 (.062)	1.80 (.070)	3.50 (.137)	
	42820-4222	42820-4223	2.36 (.093)	2.60 (.102)	5.10 (.200)	
	42820-4232	42820-4233	3.18 (.125)	3.40 (.133)		
	42820-4242	42820-4243	6.35 (.250)	6.58 (.259)	8.30 (.327)	
5	42820-5212	42820-5213	1.57 (.062)	1.80 (.070)	3.50 (.137)	
	42820-5222	42820-5223	2.36 (.093)	2.60 (.102)	5.10 (.200)	
	42820-5232	42820-5233	3.18 (.125)	3.40 (.133)		
	42820-5242	42820-5243	6.35 (.250)	6.58 (.259)	8.30 (.327)	
6	42820-6212	42820-6213	1.57 (.062)	1.80 (.070)	3.50 (.137)	
	42820-6222	42820-6223	2.36 (.093)	2.60 (.102)	5.10 (.200)	
	42820-6232	42820-6233	3.18 (.125)	3.40 (.133)		
	42820-6242	42820-6243	6.35 (.250)	6.58 (.259)	8.30 (.327)	

* Select Gold headers recommended. See product specification for additional information.

E

Power Connectors

10.00mm (.393") Pitch Mini-Fit Sr.™ Receptacle and TPA Clip

43914/43980 Dual Row

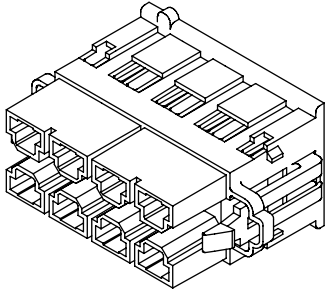

Features and Benefits

- High current
- Fully polarized
- Positive locks
- Low engagement force
- Wire-to-wire, wire-to-board (vertical only)
- Mandatory 43980 Series Terminal Position Assurance (TPA) clip, order separately

Reference Information

Product Specification: PS-42815-001
 Packaging: Bag
 UL File No.: E29179
 CSA File No.: LR19980
 TUV License No: R9751144
 Mates With: 43938 plug housing and 43915 header
 Use With: 42815 female terminal and 43980 Terminal Position Assurance (TPA) clip
 Designed In: Millimeters

Electrical

Voltage: 600V
 Current: 43.0A max*
 Insulation Resistance: 1000 Megohms min.
 Dielectric withstanding voltage: 2200V

Mechanical

Contact Insertion Force: 29.4N max.
 Contact Retention to Housing: 98.1N min.

Physical

Housing: Polyester, UL 94V-0
 *Depending on circuit size, wire gauge and PCB. Please refer to product specification.

Dual Row Receptacles		TPA Clip	
Circuits	Order No.	Circuits	Order No.
6	43914-1101	6	43980-1001
8	43914-1102	8	43980-1002
10	43914-1103	10	43980-1003
12	43914-1104	12	43980-1004
14	43914-1105	14	43980-1005

10.00mm (.393") Pitch Mini-Fit Sr.™ Plug and TPA Clip

43938/43980 Dual Row Panel Mount

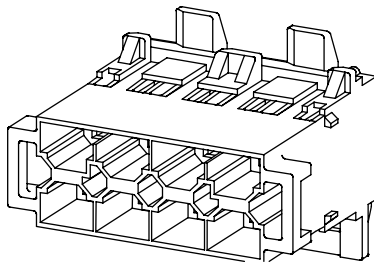

Features and Benefits

- High current
- Fully polarized
- Positive locks
- Low engagement force
- Wire-to-wire
- Mandatory 43980 Series Terminal Position Assurance (TPA) clip, order separately

Reference Information

Product Specification: PS-42815-001
 Packaging: Bag
 UL File No.: E29179
 CSA File No.: LR19980
 TUV License No: R9751144
 Mates With: 43914 Receptacle housing
 Use With: 42817 male terminal and 43980 Terminal Position Assurance (TPA) clip
 Designed In: Millimeters

Electrical

Voltage: 600V
 Current: 43.0A max*
 Insulation Resistance: 1000 Megohms min.
 Dielectric withstanding voltage: 2200V

Mechanical

Contact Insertion Force: 29.4N max.
 Contact Retention to Housing: 98.1N min.

Physical

Housing: Polyester, UL 94V-0
 *Depending on circuit size and wire gauge. Please refer to product specification.

Dual Row Plug		TPA Clip	
Circuits	Order No.	Circuits	Order No.
6	43938-2101	6	43980-1001
8	43938-2102	8	43980-1002
10	43938-2103	10	43980-1003
12	43938-2104	12	43980-1004
14	43938-2105	14	43980-1005

10.00mm (.393") Pitch Mini-Fit Sr.™ Header

43915

**Vertical, Dual Row
Metal Clip Mount**

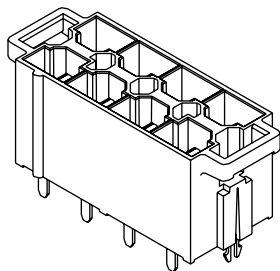

Features and Benefits

- High current
- Fully polarized
- Positive locks
- Low engagement force
- Metal board retention clips
- Wire-to-board

Reference Information

Product Specification: PS-42815-0001
Packaging: Tray
UL File No.: E29179
CSA File No.: LR19980
TUV License No: R9751144
Mates With: 43914 receptacle housing
Designed In: Millimeters

Electrical

Voltage: 600V
Current: 37.0A max.*
Contact Resistance: 1.5 milliohms max.
Dielectric Withstanding Voltage: 2200V
Insulation Resistance: 1000 Megohms min.

Mechanical

Insertion Force to PCB: 19.6kg max.
Normal Force: 1.96N min.
Durability: Tin—30 cycles; Gold—100 cycles

Physical

Housing: Glass-filled, 4/6 nylon, UL 94V-0
Contact: Copper Alloy
Plating: Tin or Select Gold
PCB Thickness: 1.57, 2.36, 3.18 or 6.35mm
(.062, .093, .125 or .250")

* Depending on circuit size, wire gauge and PCB. Please refer to product specification.

Circuits	Order No.		PCB Thickness	Lead-free
	Tin*	Select Gold		
6	43915-1101	43915-1201	1.57 (.062)	Yes
	43915-1106	43915-1206	2.36 (.093)	
	43915-1111	43915-1211	3.18 (.125)	
	43915-1116	43915-1216	6.35 (.250)	
8	43915-1102	43915-1202	1.57 (.062)	
	43915-1107	43915-1207	2.36 (.093)	
	43915-1112	43915-1212	3.18 (.125)	
	43915-1117	43915-1217	6.35 (.250)	
10	43915-1103	43915-1203	1.57 (.062)	
	43915-1108	43915-1208	2.36 (.093)	
	43915-1113	43915-1213	3.18 (.125)	
	43915-1118	43915-1218	6.35 (.250)	

* Select Gold headers recommended. See product specification for additional information.

Circuits	Order No.		PCB Thickness	Lead-free
	Tin*	Select Gold		
12	43915-1104	43915-1204	1.57 (.062)	Yes
	43915-1109	43915-1209	2.36 (.093)	
	43915-1114	43915-1214	3.18 (.125)	
	43915-1119	43915-1219	6.35 (.250)	
	14	43915-1105	43915-1205	
43915-1110		43915-1210	2.36 (.093)	
43915-1115		43915-1215	3.18 (.125)	
43915-1120		43915-1220	6.35 (.250)	

www.molex.com/product/power/minisr.html

10.30mm (.405") Stack EXTreme ZPower™ Connector Parallel Board Spacing

76001

Right Angle, Signal Only

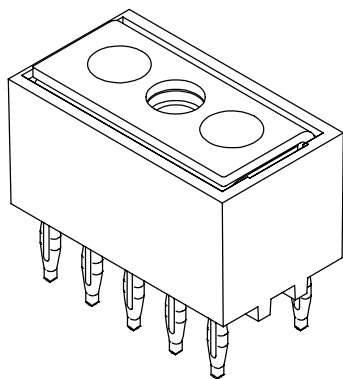

Features and Benefits

- Patented internal terminal design allows a rigid, secure interface while helping to isolate press-fit pins from the load of shock and vibration
- Screw contact interface can accept standard wire-crimp, ring-lug terminals for wire-to-board applications (Tin plating for use with ring lug terminal connection)
- Captured internal nut for ease of assembly
- High normal force, high-reliability interface
- One piece ridged Board-to-Board high current interconnect
- Hertzian (high pressure) contact areas create a reliable (gas-tight) mating surface

Reference Information

Packaging: Tray
UL File No.: E29179
Designed In: Millimeters

Electrical

Voltage: 600V max.
Current: 10 Circuit—50.0A max.
6 Circuit—30.0A max.
Contact Resistance (per blade):
Initial—0.15 milliohms
End of Life—0.10 milliohms max. change
Dielectric Withstanding Voltage: 1500VDC
Insulation Resistance: 5000 Megohms min.

Mechanical

MInsertion Force to PCB: 9.07N (20lbf) per tail
Recommended Torque: 0.75 N-m (6.6 Inch-lbs)
Durability: 5 cycles

Physical

Housing: LCP, UL 94V-0
Contact: Copper Alloy
Plating:
Contact Area—30μ" Gold min.
or 100μ" select matte Tin min.
Solder Tail Area—100μ" select matte Tin min.
Underplating—50μ" Nickel min.

Order No.	Tails	Current	Plating	Mating PCB Thickness	Press-Fit PCB Thickness	Lead Free
76001-0006	6	30.0A	Gold	0.063" 0.093" 0.125"	0.093"	Yes
76001-0106	6		Tin			
76001-0010	10	50.0A	Gold			
76001-0110	10		Tin			

www.molex.com/product/ext-zpwr.html



MX10 E-27

E

Power Connectors

EXTreme PowerPlus™ (SSI) Expandable Power and Signal Connectors

Features and Benefits

- Recessed pins-sequential mating (last-mate/first-break) allows hot swapping of power supply units
- Guide pockets (headers) or guide posts (receptacles) facilitate easy blind-mating
- Shrouded headers prevent contact damage
- Stamped and selectively-plated power contacts provide greater electrical reliability
- Rigid tails for easy PCB insertion
- Metal forklocks or screw mounts for strong board retention reduce board warpage during soldering
- High-temperature thermoplastic housing material ensures thermal reliability

E

Power Connectors

SELECTION GUIDE

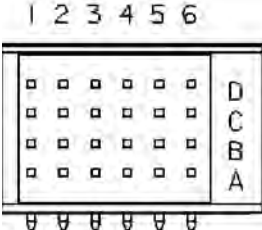
Gender	- Plug (Male) - Receptacle (Female)
Connector Orientation	- Vertical - Right Angle
Termination Method	- Through Hole - Press-Fit
Type	- Power-Signal-Power (P-S-P) - Power(Alpha)-Signal (Pa-S) - All Power (AP) - Signal-Power(Beta) (S-Pb) - AC Power/DC Power (AC/DC)
Power and Signal	- Number of power at Alpha (Example: 2 power pins at Alpha = 2 Pa) - Number of Signal pins (Example: 24 signal pins = 24 S) - Number of power at Beta (Example: 3 power pins at Beta = 3 Pb)
Recess	- Recess Power only on Receptacle Power Alpha or Beta (Example: Recess Pa #1, Pb #3 etc.) - Recess Signal only on Plug (Example: Recess Signal at A3, B4 etc.) 
Retention to PCB	- Board Lock - Screw Mount
Guide Post	- With Guide Post - Without Guide Post
Pitch	- DC Power: 6.35mm (.25") Pitch - AC Power: 7.62mm (.30") Pitch

EXTreme PowerPlus™ (SSI) Expandable Power and Signal Connectors

Electrical

Voltage: Power—50V
 Signal—50V
 Current: Power—30A
 Signal—2.5A
 Contact Resistance: Power—0.5 milliohms max.
 Signal—20 milliohms max.
 Dielectric Withstanding Voltage: Power—2,500V AC
 Signal—1,000V AC
 Insulation Resistance: Power—20,000 Megohms min.
 Signal—5,000 Megohms min.

Mechanical

Mating Force: Power—6.95N (1.56 lb) per pin
 Signal—1.00N (.22 lb) per pin
 Unmating Force: Power—2.23N (.50 lb) per pin
 Signal—0.10N (.022 lb) per pin
 Durability: 100 cycles

Physical

Unmated Height: 12.09mm (.476")
 Housing: Black glass-filled high-temperature thermoplastic, UL 94V-0
 Contact: Copper Alloy
 Plating: Contact—0.76µm (30µ") Gold
 Tail—2.54µm (100µ") Tin
 Underplating: Nickel

E

Power Connectors

SSI - MPS

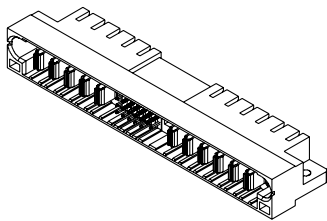

87615
 Right Angle,
 Through Hole Header

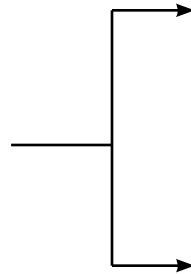

87616
 Right Angle,
 Through Hole Receptacle

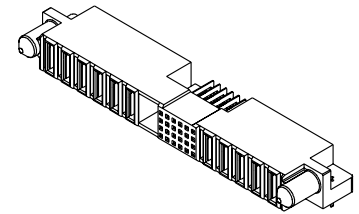

87665
 Vertical,
 Press-Fit Receptacle

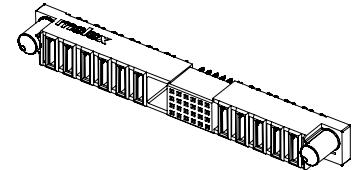

SSI - DPS

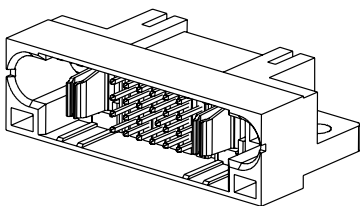

87606
 Right Angle,
 Through Hole Header

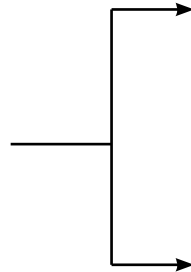

87607
 Right Angle,
 Through Hole Receptacle

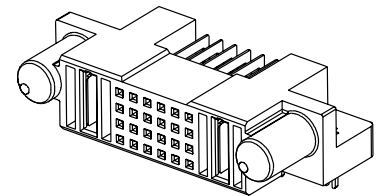

87695
 Vertical,
 Press-Fit Receptacle

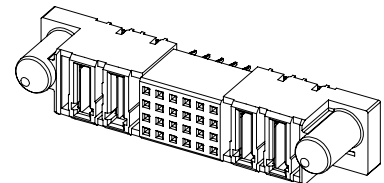

EXTreme PowerPlus™ (SSI) Expandable Power and Signal Connectors

Power-Signal-Power (P-S-P)

Power Connectors

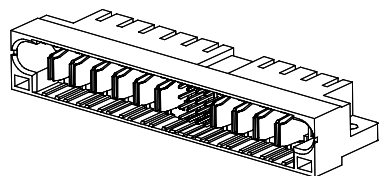

87631
Right Angle,
Through Hole Header

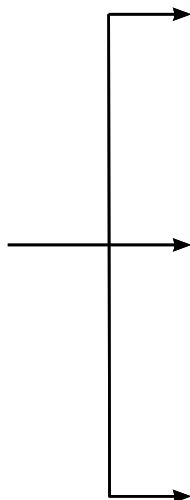

87632
Right Angle,
Through Hole Receptacle

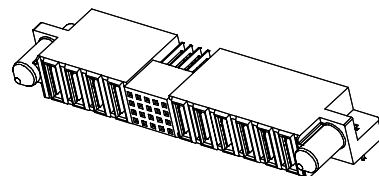

87622
Vertical,
Through Hole Receptacle

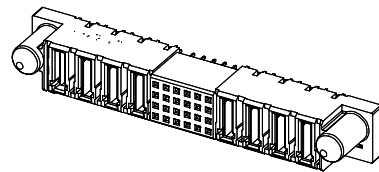

87633
Vertical,
Press-Fit Receptacle

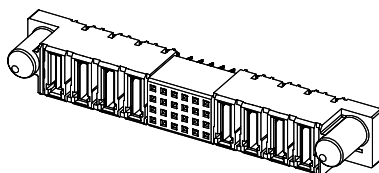

All Power

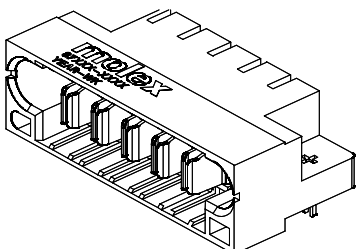

87658
Right Angle,
Through Hole Header



87633
Vertical,
Press-Fit Receptacle

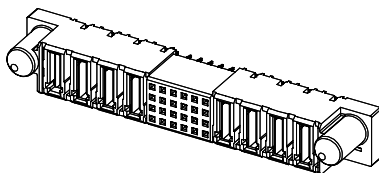

Power(Alpha)-Signal (Pa-S)

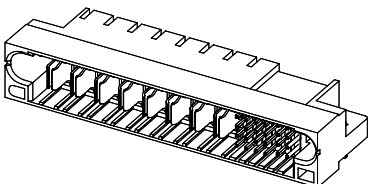

87696
Right Angle,
Through Hole Header

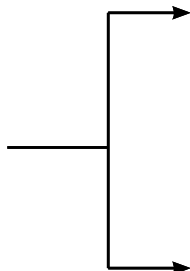

87700
Right Angle,
Through Hole Receptacle

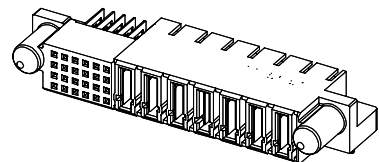

87697
Vertical,
Press-Fit Receptacle

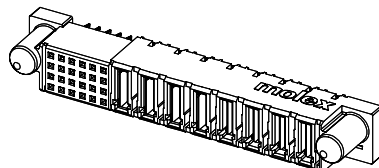

EXTreme PowerPlus™ (SSI) Expandable Power and Signal Connectors

Signal-Power(Beta) (S-Pb)

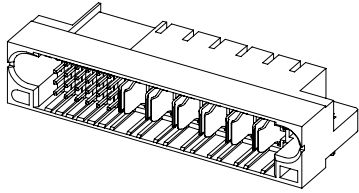

87667
Right Angle,
Through Hole Header

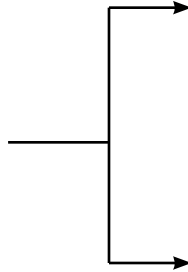

87668
Right Angle,
Through Hole Receptacle

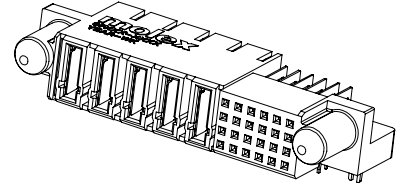

87710
Vertical,
Press-Fit Receptacle

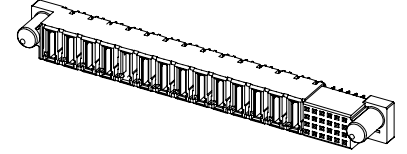

E

Power Connectors

AC/DC

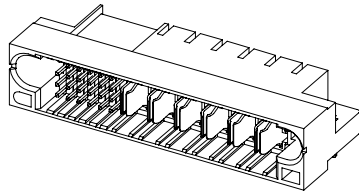

87663
Right Angle,
Through Hole Header

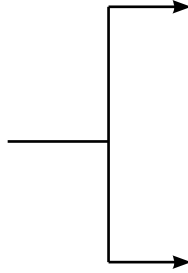

87664
Right Angle,
Through Hole Receptacle

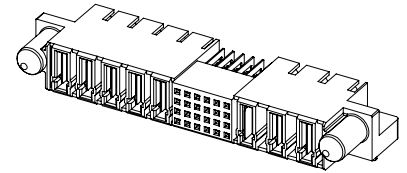

87734
Vertical,
Through Hole Receptacle

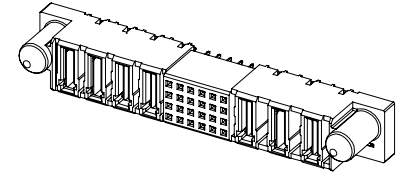

5.00mm (.197") Pitch Wire-to-Wire/Wire-to-Tab Receptacle Housing

94535

**For Female Terminals
With Secondary Lock**

Features and Benefits

- Rast 5 crimping technology
- Used for domestic appliances
- Secondary locking
- Designed for high currents

Reference Information

Packaging: Box
Use With: 94518 and 94539 Terminals
Designed In: Millimeters

Mechanical

Contact Insertion Force: 20N (4.50 lb) max.
Contact Retention to Housing: 100N (22.48 lb) min.
Durability: 100 cycles

Physical

Housing: White PA 66, UL 94V-2
Mating Force: 1.0kgf max. (2.2 lb) per contact
Normal Force: 375gf max. (0.32 lb)

E

Power Connectors

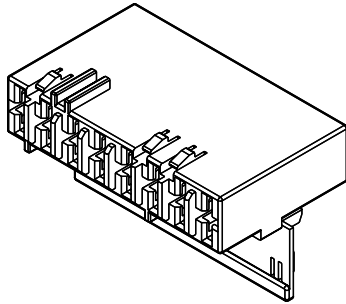

Circuits	Order No.
2	94535-7002
4	94535-7004
8	94535-7008

www.molex.com/customer.html?seriesNumber=94535

5.00mm (.197") Pitch PCB Header

94213

**4 Circuit
Vertical**

Features and Benefits

- Rast 5 technology
- Used for domestic appliances

Reference Information

Packaging: Box
Mates With: 84540 housing
Designed In: Millimeters

Electrical

Voltage: 250V
Current: 25.0A max.
Contact Resistance: 30 milliohms max.
Dielectric Withstanding Voltage: 1500V
Insulation Resistance: 5000 Megohms min.

Mechanical

Contact Insertion Force: 6N (1.35 lb) max.
Mating Force: 30N (6.74 lb) max.
Unmating Force: 8N (1.80 lb) min.
Durability: 100 cycles

Physical

Housing: PA 66, UL 94V-2
Contact: Brass
Plating: Preplated Tin
PCB Thickness: 1.50mm (.059")

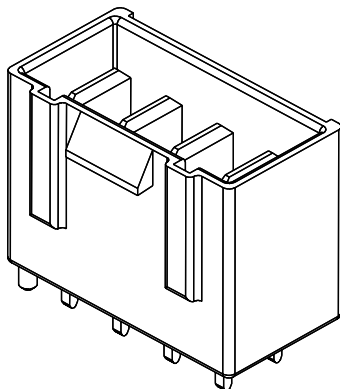

Order No.	Color	Lead-free
94213-2004	White	Yes
94213-2014	Black	

5.00mm (.197") Pitch PCB Header

94213 4 Circuit Right Angle

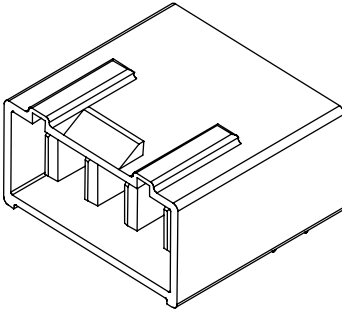

Order No.	Color	Lead-free
94213-1004	White	Yes
94213-1014	Black	

Features and Benefits

- Rast 5 technology
- Used for domestic appliances

Reference Information

Packaging: Box
Mates With: 84540 housing
Designed In: Millimeters

Electrical

Voltage: 250V
Current: 25.0A max.
Contact Resistance: 30 milliohms max.
Dielectric Withstanding Voltage: 1500V
Insulation Resistance: 5000 Megohms min.

Mechanical

Contact Insertion Force: 6N (1.35 lb) max.
Mating Force: 30N (6.74 lb) max.
Unmating Force: 8N (1.80 lb) min.
Durability: 100 cycles

Physical

Housing: PA 66, HB
Contact: Brass
Plating: Preplated Tin
PCB Thickness: 1.50mm (.059")

3.18mm (.125") Pin Diameter HCS-125 Pin and Socket Female Crimp Terminal

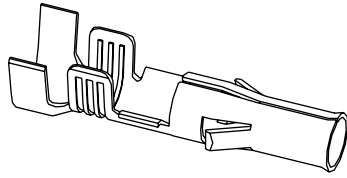

Features and Benefits

- Round contact design for easy insertion into housing
- High current in pin and socket format

Reference Information

UL File No.: E29179
CSA File No.: LR19980
Use With: 42179 receptacle housing
Designed In: Inches

Electrical

Current: 20A max.
Contact Resistance: 10 milliohms max.

Mechanical

Contact Retention to Housing: 88.96N min.
Mating Force: 24.78N max.
Unmating Force: 8.90N min.
Mating Cycles: 25 mating/unmating cycles max.

Physical

Contact: Brass or Phosphor Bronze
Plating: Tin

Type	Wire Size AWG	Maximum Insulation Diameter	Series	Order No.		Lead-free
				Chain	Loose	
Brass	10-14	4.57 (.180)	1901	18-12-1601	18-12-1602	Yes
	16-18	3.04 (.120)	2047	18-12-1221	18-12-1222	
Phosphor Bronze		10-14	4.57 (.180)	42555	18-12-1605	
	4.57 (.180)		42547	18-12-1603	18-12-1604	
	16-18	3.04 (.120)	8947	18-12-1404		

3.18mm (.125") Pin Diameter HCS-125 Pin and Socket Male Crimp Terminal

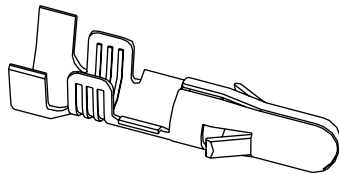

Features and Benefits

- Round contact design for easy insertion into housing
- High current in pin and socket format

Reference Information

UL File No.: E29179
CSA File No.: LR19980
Use With: 42179 plug housing
Designed In: Inches

Electrical

Current: 20A max.
Contact Resistance: 10 milliohms max.

Mechanical

Contact Retention to Housing: 88.96N min.
Mating Force: 24.78N max.
Unmating Force: 8.90N min.
Mating Cycles: 25 mating/unmating cycles max.

Physical

Contact: Brass or Phosphor Bronze
Plating: Tin

Type	Wire Size AWG	Maximum Insulation Diameter	Series	Order No.		Lead-free
				Chain	Loose	
Brass	10-14	4.57 (.180)	1900	18-12-2601	18-12-2602	Yes
	16-18	3.04 (.120)	2046	18-12-2221	18-12-2222	
Phosphor Bronze		10-14	4.57 (.180)	42554	18-12-2405	
	4.57 (.180)		42546	18-12-1607		

8.38mm (.330") Pitch HCS-125 Crimp Terminal Housing Receptacle

42179
Single Row

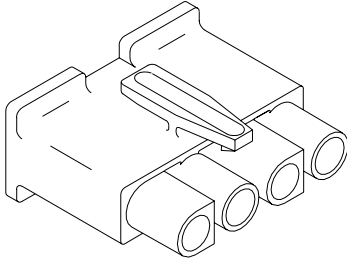

Circuits	Order No.
1	03-12-1016
2	03-12-1026
3	03-12-1036
4	03-12-1046

Features and Benefits

- Meets the need for a connector system rated at greater than industry standards
- Positive locks prevent accidental unmating
- Individual terminal silos protect terminals
- Pull tabs for easy disengagement
- 1, 2, 3 and 4 circuit housings

Reference Information

UL File No.: E29179
CSA File No.: LR19980
TUV License No.: R9151436
Mates with: 42179 Plug housing
Use With: .125" terminals

Electrical

Voltage: 600V
Current: 20.0A

Mechanical

Contact Retention to Housing: 88.96N min.

Physical

Housing: Nylon, UL 94V-2
Wire Range: See product specification and application tooling specification

8.38mm (.330") Pitch HCS-125 Crimp Terminal Housing Plug

42179
Single Row

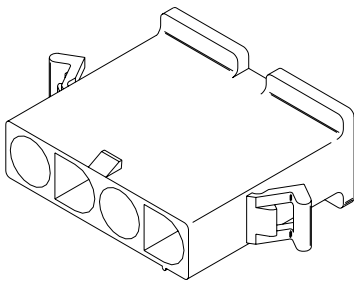

Circuits	Order No.	
	Panel Mount	Free Hanging
1	03-12-2015	03-12-2016
2	03-12-2025	03-12-2026
3	03-12-2035	03-12-2036
4	03-12-2045	03-12-2046

Features and Benefits

- Meets the need for a connector system rated at greater than industry standards
- Positive locks prevent accidental unmating
- Fully isolated terminals protect terminals
- Pull tabs for easy disengagement
- 1, 2, 3 and 4 circuit housings

Reference Information

UL File No.: E29179
CSA File No.: LR19980
TUV License No.: R9151436
Mates With: 42179 Receptacle housing
Use With: .125" terminals

Electrical

Voltage: 600V
Current: 20.0A max.

Mechanical

Contact Retention to Housing: 88.96N min.

Physical

Housing: Nylon, UL 94V-2
Wire Accommodation: See product specification and application specification

7.50mm (.295") Pitch Sabre™ Introduction

Today's manufacturing environment demands constant improvements in quality standards, increased productivity and lower production costs. With the Sabre power connector system these challenges can be met.

The Sabre system is a robust power connector supplying up to 18 amperes for high current applications. Designed and patented by Molex engineers, Sabre standardizes manufacturing footprints by offering both wire-to-wire and wire-to-board configurations. Whether your design requires 18 AWG or 14 AWG wire, the Sabre power connector system provides the flexibility of accepting a wide range of wire gauges and insulation thicknesses.

Sabre connectors offer other benefits to successfully fit the needs of your power connector applications. A primary locking feature designed on the Sabre terminal locks the terminal in place in the housing. In addition, the terminal is designed with a Terminal Position Assurance (TPA) feature that virtually eliminates terminal backout. Activation of the TPA feature is optional. The positive locking latch on the receptacle housing prevents accidental disconnection. This anti-tangle designed latch also ensures ease of handling during production. Made of nylon V-0 or V-2 material, the housings are impact resistant and withstand rough treatment during assembly.

E

Power Connectors

THE SABRE ADVANTAGE

Features

- Ideal for 14 to 18 AWG wire range.....
- Fully isolated terminals
- Positive thumb latch
- Audible click when latched
- Four points of electrical contact
- Terminal base material of Brass with Tin plating
- Anti-tangle latch on receptacle housing.....
- Plug and receptacle housing molded in 94V-0 or 94V-2 material
- Integral Terminal Position Assurance (TPA)
- No secondary plastic locking parts
- Dual truss-style locking device on female terminal
- Solder tail lengths of .150 and .210" dimensions
- Optional board lock feature offered in .062, .093 and .125" lengths.....

Contact factory to inquire about availability of terminal, housing or header components that meet the UL 1950 standard for finger proofing in environments where contact safety is a consideration.

Benefits

- Accommodates wide range of wire insulation thicknesses and double wire crimps
- Provide terminal protection and polarization
- Prevents accidental disengagement
- Reassures operators latch is engaged
- Provide more reliable electrical connection
- Cost effective base material
- Prevents breakage and makes production handling easy
- Withstands operating temperature ranges from -40 to +75°C
- Virtually eliminates terminal backout
- Eliminate costs of handling and inventory of secondary parts
- Provides more robust primary locking mechanism of terminal in housing
- Fit a wide range of PC board thicknesses
- For most popular PC board thicknesses

7.50mm (.295") Pitch Sabre™

- Wire-to-Wire (free hanging only)
- Wire-to-Board
- Patented Terminal Position Assurance (TPA) feature

- Voltage: 600V
 - Current: 18.0A* per circuit
 - UL 1950 Finger Proof Safe available
- *Depending on circuit size, wire gauge and PCB design

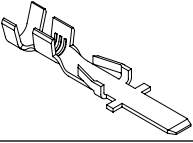
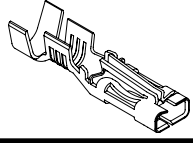
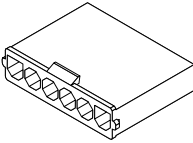
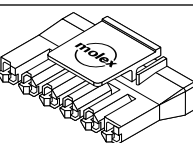
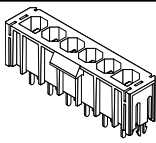
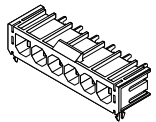
	Series	Description	Mates With/ Use With	Material	Circuits/ Wire Gauge	Features and Benefits
Terminals						
	43178	Male Terminal	Mates with 43375 Terminals Used in 43680 Housings	Tin-plated Brass	14 to 18 AWG or double 18 AWG crimps	<ul style="list-style-type: none"> • Four points of electrical contact between terminal mating interface provides a more reliable electrical connection • Patented integral Terminal Position Assurance (TPA) on mated male and female terminals. Activation is optional. Virtually eliminates terminal backouts from housing • Male terminal part numbers available for use with 43680 plug housings that meet UL 1950 finger proofing in environments where contact safety is a consideration
	43375	Female Terminal	Mates with 43178 Terminal and 43160 Headers Used in 44441 Housings			
Single Row Housings						
	43680	Plug Housing	Mates with 44441	Nylon, UL 94V-0 or UL 94V-2	2, 3, 4, 5 and 6 Circuits	<ul style="list-style-type: none"> • Positive thumbblatch on receptacle prevents accidental disengagement with plug or header • Receptacle thumbblatch has anti-tangle design to prevent breakage during harness assembly and improves production handling • Polarized housing helps prevent improper mating • 43680 plug housings meet UL 1950 finger proofing requirements when used with designated 43178 male terminals. 44441 receptacle housings meet same requirement when used with standard 43375 female terminals
	44441	Receptacle Housing	Mates with 43680 and 43160			
Single Row Headers						
	43160	Vertical Header	Mates with 44441	Glass-filled Nylon, UL 94V-0	2, 3, 4, 5 and 6 Circuits	<ul style="list-style-type: none"> • Individual part numbers available to match 1.57, 2.36 or 3.17mm (.062, .093 or .125") PCB thicknesses • Optional PCB retention clips for secure retention of the header to the PCB prior to and during the solder process • Special part numbers available upon request that meet UL 1950 finger proofing requirements
		Right Angle Header				

*Wave solder compatible only

Terminal TPA Activation/Deactivation and Extraction Hand Tools

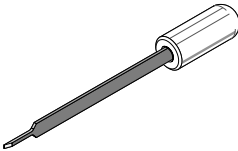
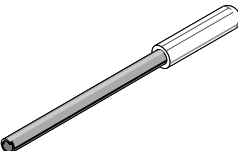
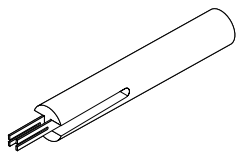
	Order No.	Used With	Features and Benefits
	63813-0500	44441 Receptacle Housing 43375 Female Terminal	<ul style="list-style-type: none"> • Female terminal extraction • TPA activation • TPA de-activation
	63813-0600	43680 Plug Housing 43178 Male Terminal	<ul style="list-style-type: none"> • Male terminal TPA activation • TPA de-activation
	63813-0800		<ul style="list-style-type: none"> • Male terminal extraction

7.50mm (.295") Pitch Sabre™ Wire-to-Wire or Wire-to-Board Terminal

43375
Female

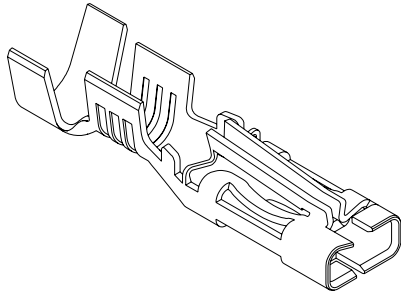

Features and Benefits

- Patented new integral Terminal Position Assurance (TPA) on female and male terminal virtually eliminates terminal backout
- Four points of electrical contact
- Wire-to-wire; wire-to-board

Reference Information

Product Specification: PS-44441-9999
UL File No.: E29179
CSA File No.: LR19980
TUV License No.: TBA
Use With: 44441 housing

Electrical

Current: 18.0A max.*
Voltage: 600V
Contact Resistance: 10 milliohms max.

Mechanical

Mating Force: 13.3N max.
Unmating Force: 2.2N min.
Normal Force: 13.34N nominal per contact
Mating Cycles: 25

Physical

Contact: Brass
Plating: Tin
Wire Gauge: 14, 16, 18 AWG
Insulation Diameter: 4.57mm (.180") max

* Depending on circuit size, wire gauge and PCB. Please refer to product specification.

Order No.	Plating	Wire Size AWG	Maximum Insulation Diameter	Packaging	Lead-free
43375-0001	Tin	14-18	3.30 (.130)	Chain	Yes
43375-1001			4.57 (.180)		

† Accommodates single 14, 16 or 18 AWG wire crimps or double 18 AWG wire crimps

7.50mm (.295") Pitch Sabre™ Wire-to-Wire Terminal

43178
Male

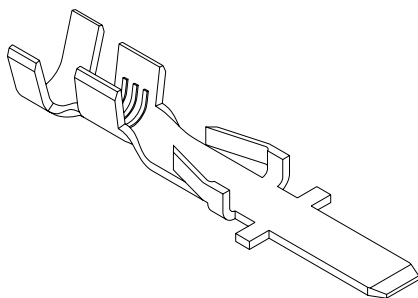

Features and Benefits

- Patented new integral Terminal Position Assurance (TPA) on male and female terminal virtually eliminates terminal backout
- Accommodates 14 to 18 gauge wire
- Four points of electrical contact
- Wire-to-wire

Reference Information

Product Specification: PS-44441-9999
UL File No.: E29179
CSA File No.: LR19980
TUV License No.: TBA
Use With: 43680 housing

Electrical

Voltage: 600V
Current: 18.0A max.*
Contact Resistance: 10 milliohms max.
Dielectric Withstanding Voltage: 5000V
Insulation Resistance: 1000 Megohms min.

Mechanical

Mating Force: 13.3N max.
Unmating Force: 2.2N min.
Normal Force: 13.34N nominal
Durability: 25 cycles

Physical

Contact: Brass
Plating: Tin
Wire Gauge: 14, 16, 18 AWG
Insulation Diameter: 4.57mm (.180") max.

* Depending on circuit size and wire gauge. Please refer to product specification.

Order No.	Wire Size AWG	Maximum Insulation Diameter	Packaging	Lead-free
43178-1002	18	3.30 (.130)	Chain	Yes
43178-2002	14-18	4.57 (.180)		

† Accommodates single 14, 16 or 18 AWG wire crimps, or double 18 AWG wire crimps

7.50mm (.295") Pitch Sabre™ Receptacle

44441
Single Row

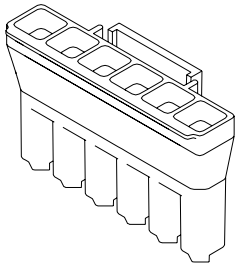

Circuits	Order No.	
	94V-2	94V-0
2	44441-1002	44441-2002
3	44441-1003	44441-2003
4	44441-1004	44441-2004
5	44441-1005	44441-2005
6	44441-1006	44441-2006

Features and Benefits

- Patented new integral Terminal Position Assurance (TPA) on mated male and female terminal virtually eliminates terminal backout
- Wire-to-wire and wire-to-board connector system
- Polarized housing assures proper mating
- Terminals are fully isolated in housing
- Positive latch reduces accidental disengagement from plug

Reference Information

Product Specification: PS-44441-9999
 UL File No.: E29179
 CSA File No.: LR19980
 TUV License No.: TBA
 Use With: 43375 terminal
 Mates With: 43160 header and 43680 plug

Mechanical

Contact Insertion Force: 8.90N max.
 Contact Retention to Housing: 88.96N min.

Physical

Housing: Nylon, UL 94V-2 or 94V-0

7.50mm (.295") Pitch Sabre™ Wire-to-Wire Plug

43680
Single Row

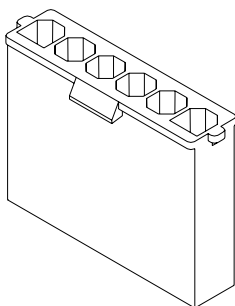

Circuits	Order No.	
	94V-0	94V-2
2	43680-2002	43680-1002
3	43680-2003	43680-1003
4	43680-2004	43680-1004
5	43680-2005	43680-1005
6	43680-2006	43680-1006

Features and Benefits

- Patented new integral Terminal Position Assurance (TPA) on mated male and female terminal virtually eliminates terminal backout
- Polarized housing assures proper mating
- Terminals are fully isolated in housing
- Positive latch reduces accidental disengagement from receptacle

Reference Information

Product Specification: PS-44441-9999
 UL File No.: E29179
 CSA File No.: LR19980
 TUV License No.: TBA
 Use With: 43178 terminal
 Mates With: 44441 receptacle

Mechanical

Contact Insertion Force: 8.90N max.
 Contact Retention to Housing: 88.96N min.

Physical

Housing: Nylon, UL 94V-2 or 94V-0

7.50mm (.295") Pitch Sabre™ Wire-to-Board Header

43160

**Vertical, Single Row
With and without Board Lock**

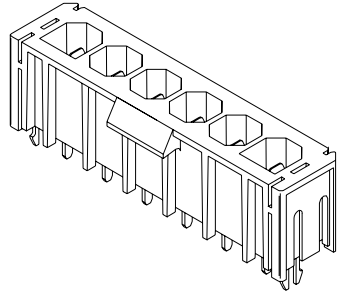

Features and Benefits

- Sizes 2 to 6 circuits
- Optional board lock features offered in 1.57, 2.36 and 3.18mm (.062, .093 and .125) lengths
- Positive lock
- Fully polarized
- Wire-to-board

Reference Information

Product Specification: PS-44441-9999
 UL File No.: E29179
 CSA File No.: LR19980
 TUV License No.: TBA
 Mates With: 44441 housing

Electrical

Voltage: 600V
 Current: 18.0A max.*
 Contact Resistance: 10 milliohms max.

Mechanical

Insertion Force to PCB: 22.24N max.
 Mating Cycles: 25

Physical

Housing: Black glass-filled nylon, UL 94V-0 or natural unfilled nylon, UL 94V-2

Contact: Brass

Plating: Tin

* Depending on circuit size, wire gauge and PCB. Please refer to product specification.

Without Board Lock				
Circuits	Order No.		PC Tail Length	Lead-free
	94V-0	94V-2		
2	43160-0102	43160-0202	3.81 (.150)	Yes
	43160-0302	43160-0402	5.33 (.210)	
3	43160-0103	43160-0203	3.81 (.150)	
	43160-0303	43160-0403	5.33 (.210)	
4	43160-0104	43160-0204	3.81 (.150)	
	43160-0304	43160-0404	5.33 (.210)	
5	43160-0105	43160-0205	3.81 (.150)	
	43160-0305	43160-0405	5.33 (.210)	
6	43160-0106	43160-0206	3.81 (.150)	
	43160-0306	43160-0406	5.33 (.210)	

With Board Lock				
Circuits	Order No.		PCB Thickness	Lead-free
	94V-0	94V-2		
2	43160-2102	43160-2202	1.57 (.062)	Yes
	43160-4302	43160-4402	2.36 (.093)	
	43160-6302	43160-6402	3.18 (.125)	
3	43160-2103	43160-2203	1.57 (.062)	
	43160-4303	43160-4403	2.36 (.093)	
	43160-6303	43160-6403	3.18 (.125)	
4	43160-2104	43160-2204	1.57 (.062)	
	43160-4304	43160-4404	2.36 (.093)	
	43160-6304	43160-6404	3.18 (.125)	
5	43160-2105	43160-2205	1.57 (.062)	
	43160-4305	43160-4405	2.36 (.093)	
	43160-6305	43160-6405	3.18 (.125)	
6	43160-2106	43160-2206	1.57 (.062)	
	43160-4306	43160-4406	2.36 (.093)	
	43160-6306	43160-6406	1.57 (.125)	

7.50mm (.295") Pitch Sabre™ Wire-to-Board Header

43160

**Right Angle, Single Row
With and without Board Lock**

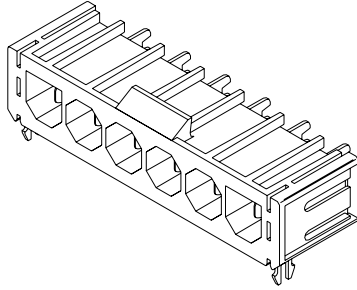

Features and Benefits

- Sizes 2 to 6 circuits
- Wire-to-board
- Optional board lock features offered in 1.57, 2.36 and 3.18mm (.062, .093 and .125") lengths
- Positive lock
- Fully polarized

Reference Information

Product Specification: PS-44441-9999
UL File No.: E29179
CSA File No.: LR19980
TUV License No.: TBA
Mates With: 44441 housing

Electrical

Voltage: 600V
Current: 18.0A max.*
Contact Resistance: 10 milliohms max.

Mechanical

Insertion Force to PCB: 22.24N max.
Normal Force: 13.34N nominal
Mating Cycles: 25

Physical

Housing: Black glass-filled nylon, UL 94V-0 or natural unfilled nylon UL 94V-2

Contact: Brass
Plating: Tin

* Depending on circuit size, wire gauge and PCB. Please refer to product specification.

Without Board Lock				
Circuits	Order No.		PC Tail Length	Lead-free
	94V-0	94V-2		
2	43160-1102	43160-1202	3.81 (.150)	Yes
	43160-1302	43160-1402	5.33 (.210)	
3	43160-1103	43160-1203	3.81 (.150)	
	43160-1303	43160-1403	5.33 (.210)	
4	43160-1104	43160-1204	3.81 (.150)	
	43160-1304	43160-1404	5.33 (.210)	
5	43160-1105	43160-1205	3.81 (.150)	
	43160-1305	43160-1405	5.33 (.210)	
6	43160-1106	43160-1206	3.81 (.150)	
	43160-1306	43160-1406	5.33 (.210)	

With Board Lock				
Circuits	Order No.		PCB Thickness	Lead-free
	94V-0	94V-2		
2	43160-3102	43160-3202	1.57 (.062)	Yes
	43160-5302	43160-5402	2.36 (.093)	
	43160-7302	43160-7402	3.18 (.125)	
3	43160-3103	43160-4203	1.57 (.062)	
	43160-5303	43160-5403	2.36 (.093)	
	43160-7303	43160-7403	3.18 (.125)	
4	43160-3104	43160-3204	1.57 (.062)	
	43160-5304	43160-5404	2.36 (.093)	
	43160-7304	43160-7404	3.18 (.125)	
5	43160-3105	43160-3205	1.57 (.062)	
	43160-5305	43160-5405	2.36 (.093)	
	43160-7305	43160-7405	3.18 (.125)	
6	43160-3106	43160-3206	1.57 (.062)	
	43160-5306	43160-5406	2.36 (.093)	
	43160-7306	43160-7406	3.18 (.125)	

Specialty Power Connectors

Introduction

The connectors shown in this Specialty Connector section offer the high current capabilities used in power applications, along with special features to meet unique industry needs. Included here are new wire-to-wire and wire-to-board connectors with Terminal Retainer features. These connectors utilize a flat male tab and female receptacle contact system that offers low insertion force and rugged features for low-circuit size applications in the white goods, automotive and other harsh environments.

3.96 (.156) and 6.50mm (.246") Pitch iLock™ Connectors

This iLock is offered in the industry standard 3.96mm pitch size for both wire-to-wire and wire-to-board applications. The system's female terminal also is used with a similar 6.50mm (.256") pitch wire-to-board series.

Features

9A max., 600V
 Long tab-style terminal
 Inner positive lock
 Terminal locking tangs
 Housing side walls
 Housing side ribs
 One-piece locking ears
 Terminal Retainer
 Header snap-fit pegs
 Stand-offs
 UL 94V-0 material

Benefits

Ideal for white goods applications
 Low insertion force and secure contact
 Easy attachment and secure mating retention
 Guide for retainer
 Protect latch and facilitate mating
 Polarization
 Good spring characteristics and secure panel retention
 Additional terminal retention and easy attachment
 Secure PCB retention
 Prevent flux wicking
 Withstands harsh environments

1.80mm (.070") Pitch VersaBlade™ Wire-to-Wire Connectors

Molex's line of 1.80mm (.070") VersaBlade wire-to-wire connectors are designed around the system's industry standard .070" width male "tab"-style terminal. This terminal system has gained wide usage in the white goods and automotive markets, particularly in the Far East.

Features

15A max., 300V
 Wide 1.80mm (.070") male tab contact
 Low insertion force
 Dual-row system
 TPA secondary lock
 Housing locking terminal
 Terminal dimples and housing polarization features
 Positive lock
 Spring-style mounting ears
 UL 94V-0 material

Benefits

Meets white goods, automotive and other power requirements
 Enables high current carrying capability
 Easy mating/unmating even for larger circuit sizes
 Provides good heat dissipation and lower engagement forces than 3-rows
 Ensures high reliability terminal seating and contact
 Prevents terminal deformation
 Prevents incorrect terminal insertion and mis-mating
 Secure mating retention
 Prevent breakage
 Withstands harsh environments

1.80mm (.070") Width VersaBlade™ Wire-to-Wire Terminal

35746/35748
Female, Crimp
With Polarizing Dimple

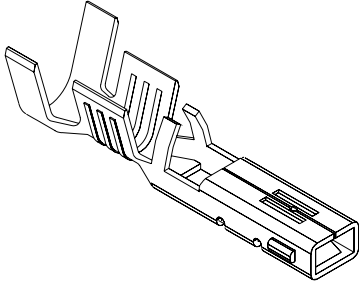

Features and Benefits

- Low insertion force
- Housing-locking feature avoids deformation of terminal
- Fully enclosed box design protects contact area from damage and provides 3 points of contact
- Accepts wide wire range (14 to 22 AWG)
- Strip length: 4.0 to 4.8mm

Reference Information

Product Specification: PS-35150
Tooling Information: Semi-automatic crimping press and applicator
Mates With: 35745 and 35747 male terminals
Use With: 35150, 35151, 35180 and 35181 housings

Electrical

Voltage: 300V
Current: 15A max. See applicable product spec.
Contact Resistance: 10 milliohms max.

Mechanical

Contact Insertion Force: 2.5kgf max.
Contact Retention to Housing: 4.0kgf min.
Wire Pull-Out Force: 14AWG—15.0kgf min.
Mating Force: 1.6kgf max.
Unmating Force: 0.5kgf min.
Mating Cycles: 30

Physical

Contact: Phosphor Bronze
Plating: Tin
Wire Range: 14-22 AWG

Order No.	Wire Range AWG	Insulation Range (max.)	Packaging	Lead-free
35746/35748-0110	20-22	2.70 (.106)	Reel	Yes
35746/35748-0210	14-18	3.40 (.134)		
35746/35748-0310	18+18, 20+20	6.00 (.236)		
35746/35748-0410	24-26	2.35 (.093)		

1.80mm (.070") Width VersaBlade™ Wire-to-Wire Terminal

35745/35747
Male, Crimp
With Polarizing Dimple

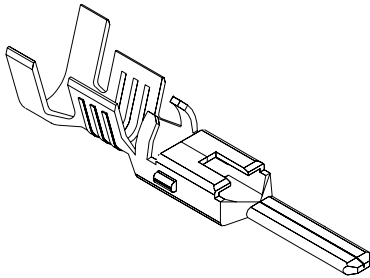

Features and Benefits

- Low insertion force
- Housing-locking feature avoids deformation of terminal
- Accepts wide wire range (14 to 22 AWG)
- Strip length: 4.0 to 4.5mm

Reference Information

Product Specification: PS-35150
Tooling Information: Semi-automatic crimping press and applicator
Mates With: 35746 and 35748 female terminals
Use With: 35150, 35151, 35180 and 35181 housings

Electrical

Voltage: 300V
Current: 15A max. See applicable product spec.
Contact Resistance: 10 milliohms max.
Dielectric Withstanding Voltage: 1500V
Insulation Resistance: 100 Megohms min.

Mechanical

Contact Insertion Force: 2.5kgf max.
Contact Retention to Housing: 4.0kgf min.
Wire Pull-Out Force: 14AWG—15.0kgf min.
Mating Force: 1.6kgf max.
Unmating Force: 0.5kgf min.
Mating Cycles: 30

Physical

Contact: Brass
Plating: Tin

Order No.	Wire Range AWG	Insulation Range (max.)	Lead-free
35745/35747-0110	20-22	2.70 (.106)	Yes
35745/35747-0210	14-18	3.40 (.134)	
35745/35747-0310	18+18, 20+20	6.00 (.236)	
35745/35747-0410	24-26	2.35 (.093)	

1.80mm (.070") Tab VersaBlade™ Wire-to-Wire Female Housing

35181

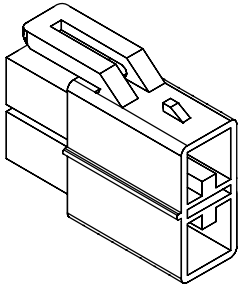

Power Connectors

Circuits	Order No.
2	35181-0200
	35181-0210
	35181-0220
	35181-0229

Features and Benefits

- Polarization prevents mismatching
- Housing-locking feature avoids deformation of terminal
- Fully-enclosed box design protects contact area from damage
- Accepts 35182-019 TPA secondary lock

Reference Information

Product Specification: PS-35180-002
 UL File No.: E29179
 CSA File No.: LR19980
 TUV License No.: R9551811
 Mates With: 35180
 Use With: 35182, 35746 and 35748

Mechanical

Contact Insertion Force: 29.4N (6.61 lb)
 Contact Retention to Housing: 39N (8.77 lb)

Physical

Housing: Polyester, UL 94V-0

1.80mm (.070") Tab VersaBlade™ Wire-to-Wire Housing

35965
Female

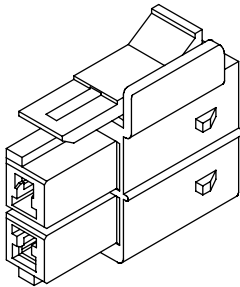

Circuits	Order No.
2	35965-0200
	35965-0210
	35965-0220
	35965-0290
	35965-9200
	35965-9210
	35965-9220

Features and Benefits

- Polarization prevents mismatching
- Housing-locking feature avoids deformation of terminal
- Fully enclosed box design protects contact area from damage
- Accepts 35965-029 TPA secondary lock

Reference Information

Product Specification: PS-35180-002
 Mates With: 35180
 Use With: 35746, 35748 and 35965

Mechanical

Contact Insertion Force: 29.4N (6.61 lb)
 Contact Retention to Housing: 39N (8.77 lb)

Physical

Housing: Polyester, UL 94V-0

1.80mm (.070") Tab VersaBlade™ Wire-to-Wire Male Housing 35180

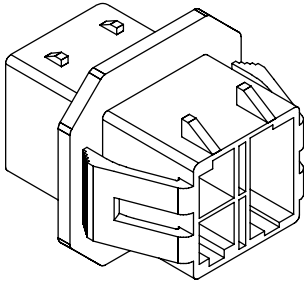

Circuits	Order No.
4	35180-0400
6	35180-0600

Features and Benefits

- Polarization prevents mismatching
- Mounting ears snap firmly into place
- Housing-locking feature avoids deformation of terminal
- Fully-enclosed box design protects contact area from damage
- Accepts 35182-029 TPA secondary lock
- Hybrid connector accommodates 4 types of terminals: female terminals 35746 and 35748, and male terminals 35745 and 35747

Reference Information

Product Specification: PS-35180-002
 UL File No.: E29179
 CSA File No.: LR19980
 TUV License No.: R9551811
 Mates With: 35181 and 35965
 Use With: 35182, 35745, 35746, 35747 and 35748

Mechanical

Contact Insertion Force: 29.4N (6.61 lb)
 Contact Retention to Housing: 39N (8.77 lb)

Physical

Housing: Polyester, UL 94V-0

1.80mm (.070") Width VersaBlade™ Wire-to-Wire Hybrid Receptacle 35151

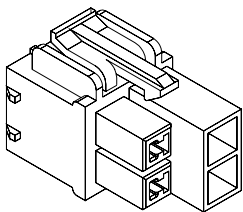

Circuits	Order No.
1	35151-0110
2	35151-0210
3	35151-0310
4	35151-0410
6	35151-0610

Features and Benefits

- Sizes 1 to 6 circuits
- Hybrid connector accommodates 4 types of terminals
- Positive lock ensures secure mating
- Polarization prevents mismatching
- Accepts 35150 TPA secondary lock

Reference Information

Product Specification: PS-35150
 UL File No.: E29179
 CSA File No.: LR19980
 TUV File No.: R9551811
 Mates With: 35150 housing
 Use With: 35745, 35746, 35747 and 35748 terminals

Mechanical

Contact Insertion Force: 2.5kgf max.
 Contact Retention to Housing: 4.0kgf min.
 Mating Force: 5.0kgf max.
 Unmating Force: 1.5kgf min.
 Mating Cycles: 30

Physical

Housing: Polyester, UL 94V-0

1.80mm (.070") Width VersaBlade™ Wire-to-Wire Hybrid Plug 35150

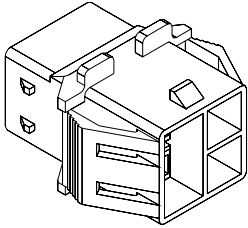

Features and Benefits

- Sizes 1 to 6 circuits
- Hybrid connector accommodates 4 types of terminals
- Positive lock ensures secure mating
- Optional mounting ears snap firmly into place
- Polarization prevents mismatching
- Accepts 35150 TPA secondary lock

Reference Information

Product Specification: PS-35150
 UL File No.: E29179
 CSA File No.: LR19980
 TUV File No.: R9551811
 Mates With: 35151 housing
 Use With: 35745, 35746, 35747 and 35748 terminals

Mechanical

Contact Insertion Force: 2.5kgf max.
 Contact Retention to Housing: 4.0kgf min.
 Mating Force: 5.0kgf max.
 Unmating Force: 1.5kgf min.
 Mating Cycles: 30

Physical

Housing: Polyester, UL 94V-0

Circuits	Order No.
1	35150-0100
2	35150-0210
3	35150-0310
4	35150-0410
6	35150-0610

1.80mm (.070") Width VersaBlade™ Wire-to-Wire TPA Secondary Lock 35150/35182

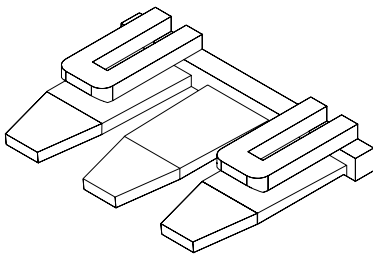

Features and Benefits

- TPA (Terminal Positioning Assurance) secondary lock ensures that terminals are fully inserted during harness assembly
- Prevents wire pull-out and adds additional stability during mating
- An audible "click" lets the operator know when the TPA lock is inserted

Reference Information

Product Specification: PS-35150
 Use With: 35150 and 35151 housings

Physical

Housing: Polyamide, UL 94V-2

Circuits	Order No.
1	35182-0190
2	35150-0290
3	35150-0390

2.36mm (.093") Pin Diameter .093" Pin and Socket Female Crimp Terminal

Standard .093" and 3191

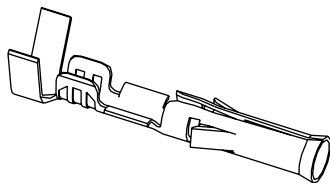

Features and Benefits

- Round contact design for easy insertion into housing
- Can be used in plug or receptacle
- Accommodates 14 to 30 gauge wire
- Available in crimp or PC tail versions

Reference Information

UL File No.: E29179
CSA File No.: LR19980
Designed In: Inches

Electrical

Current: Standard Terminal—14.0A max.*
High Current Terminal—17.0A max.*
Contact Resistance: 10 milliohms max.

Mechanical

Contact Insertion Force: 22.29N max.
Contact Retention Force: 88.96N min.
Mating Force: 15.57N max.
Unmating Force: 4.45N max.
Durability: Tin plating—25 cycles max.
Gold plating—50 cycles max.

Physical

Contact: Brass or Phosphor Bronze
Plating: Tin or Gold
Strip Length: See tooling section

* Depending on circuit size and wire gauge. Please refer to product specifications

Type	Plating	Crimp Wire Size	Insulation Diameter	Series	Order No.		Lead-free
					Chain Form	Loose Form	
Standard Brass .010"	Tin	14-20	1.65/4.06 (.065/.160)	1189	02-09-1102	02-09-1104	Yes
		18-22	1.52/3.05 (.060/.120)	1381	02-09-1117	02-09-1119	
		22-24	1.27/1.78 (.050/.070)	2871	02-09-1138	02-09-1139	
		24-30	0.76/1.52 (.030/.060)	1433	02-09-1142	02-09-1144	
	15µ" Gold	14-20	1.65/4.06 (.065/.160)	1189	02-09-5100	02-09-5106	
		18-22	1.52/3.05 (.060/.120)	1381	02-09-5143	02-09-5142	
		24-30	0.76/1.52 (.030/.060)	1433	02-09-5146	02-09-5147	
	50µ" Gold	14-20	1.65/4.06 (.065/.160)	1189	02-09-5102	02-09-5111	
		18-22	1.52/3.05 (.060/.120)	1381	02-09-5130	02-09-5133	
.013" High Current/Low Force	Tin	14-18	3.56 (.140) max.	42477	02-09-1615	02-09-1616	
PC Tail for Standard .093" Housing	Tin			1377		02-09-1134	
	30µ" Gold				02-09-5132		
Phos-Bronze .010"	Tin	14-20	1.65/4.06 (.065/.160)	4550	02-09-1205	02-09-1206	
		18-22	1.52/3.05 (.060/.120)	2151	02-09-1203	02-09-1204	
	30µ" Gold	14-20	1.65/4.06 (.065/.160)	4550	02-09-5169	02-09-5170	

2.36mm (.093") Pin Diameter .093" Pin and Socket Male Crimp Terminal

Standard .093" and 3191

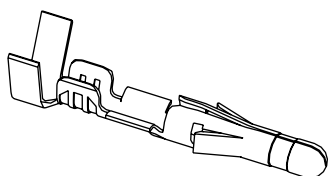

Features and Benefits

- Round contact design for easy insertion into housing
- Can be used in plug or receptacle
- Accommodates 14 to 30 gauge wire
- Available in crimp or PC tail versions

Reference Information

UL File No.: E29179
CSA File No.: LR19980

Electrical

Current: Standard terminal—14.0A max.*
High Current Terminal—17.0A max.*
Contact Resistance: 10 milliohms max.

Mechanical

Contact Insertion Force: 22.24N max.
Contact Retention Force: 88.96N min.
Mating Force: 15.57N max.
Unmating Force: 4.45N max.
Durability: Tin plating—25 cycles max.
Gold plating—50 cycles max.

Physical

Contact: Brass or Phosphor Bronze
Plating: Tin or Gold

* Depending on circuit size and wire gauge; please refer to product specifications

Type	Plating	Crimp Wire Size	Insulation Diameter	Series	Order No.		Lead-free
					Chain Form	Loose Form	
Standard Brass .010"	Tin	14-20	1.65/4.06 (.065/.160)	1190	02-09-2101	02-09-2103	Yes
		18-22	1.52/3.05 (.060/.120)	1380	02-09-2116	02-09-2118	
		22-24	1.27/1.78 (.050/.070)	2870	02-09-2136	02-09-2137	
		24-30	0.76/1.52 (.030/.060)	1434	02-09-2141	02-09-2143	
	15µ" Gold	14-20	1.65/4.06 (.065/.160)	1190	02-09-6100	02-09-6106	
		18-22	1.52/3.05 (.060/.120)	1380	02-09-6122	02-09-6123	
		24-30	0.76/1.52 (.030/.060)	1434	02-09-6144	02-09-6145	
	50µ" Gold	14-20	1.65/4.06 (.065/.160)	1190	02-09-6101	02-09-6110	
		18-22	1.52/3.05 (.060/.120)	1380	02-09-6125	02-09-6126	
Grounding Pin	Tin	14-18	1.65/3.56 (.065/.140)	1973-2	02-09-8108	02-09-8109	
		18-22	1.52/3.05 (.060/.120)	1973	02-09-8103	02-09-8104	
.013" High Current/Low Force	Tin	14-18	3.56 (.140) max.	42478	02-09-2611	02-09-2612	
PC Tail for Standard .093" Housing	Tin			1376		02-09-2134	
	30µ" Gold				02-09-6132		

5.03mm (.198") Pitch .093 Pin and Socket Crimp Terminal Housing Receptacle

Standard .093"

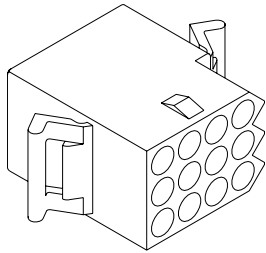

Features and Benefits

- Passive (friction) lock
- 1 to 15 circuit housings
- Panel and PCB mountable
- Mating headers available
- Male and female terminals may be used in receptacle housing

Reference Information

UL File No.: E29179
 CSA File No.: LR19980
 Mates With: Standard .093" plug and 3099 headers
 Use With: Standard .093" terminal

Electrical

Voltage: 250V
 Current: See chart

Mechanical

Contact Retention to Housing: 88.96N min.

Physical

Housing: Nylon, UL 94V-2

Circuits	Series No.	Order No.		Amperes per Circuit*
		Panel Mount	Free Hanging	
1	1619	N/A	03-09-1011	14.0
2	1545	03-09-1027	03-09-1022	
3	1396	03-09-1081	03-09-1032	
4 (1 x 4)	1490	03-09-1041	03-09-1042	11.0
4 (2 x 2)	2163	03-09-1040	03-09-1049	
5	2629	N/A	03-09-1054	
6	1261	03-09-1061	03-09-1064	9.5
9	1292	03-09-1091	03-09-1094	
12	1360	03-09-1125	03-09-1126	
15	1375	03-09-1154	03-09-1157	

* Rating based on fully loaded housings and 14 AWG wire

5.03mm (.198") Pitch .093" Pin and Socket Crimp Terminal Housing Plug

Standard .093"

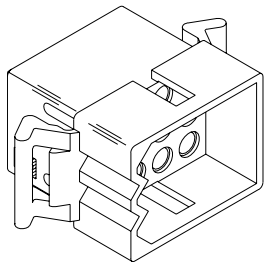

Features and Benefits

- Passive (friction) lock
- 1 to 15 circuit housings
- Panel and PCB mountable
- Male and female terminals may be used in plug housing

Reference Information

UL File No.: E29179
 CSA File No.: LR19980
 Mates With: Standard .093" receptacle
 Use With: Standard .093" terminal

Electrical

Voltage: 250V
 Current: See chart

Mechanical

Contact Retention to Housing: 20 lb min.

Physical

Housing: Nylon, UL 94V-2

Circuits	Series No.	Order No.		Amperes per Circuit*
		Panel Mount	Free Hanging	
1	1619	N/A	03-09-2011	14.0
2	1545	03-09-2021	03-09-2022	
3	1396	03-09-2031	03-09-2032	
4 (1 x 4)	1490	03-09-2041	03-09-2042	11.0
4 (2 x 2)	2163	03-09-2040	03-09-2049	
5	2629	N/A	03-09-2057	
6	1261	03-09-2061	03-09-2062	9.5
9	1292	03-09-2091	03-09-2092	
12	1360	03-09-2122	03-09-2121	
15	1375	03-09-2159	03-09-2158	

* Rating based on fully loaded housings and 14 AWG wire

5.03mm (.198") Pitch .093" Pin and Socket Shrouded Header

3099

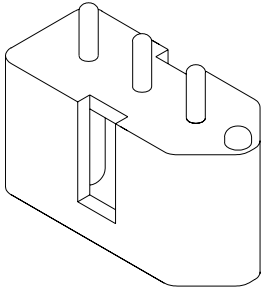

Features and Benefits

- 3, 4, 6, 9, 12 and 15 circuits available
- Pre-assembled
- Intermix of male and female terminals for polarization
- Polarized housing design assures proper mating

Reference Information

UL File No.: E29179
 CSA File No.: LR19980
 Mates With: Standard .093" receptacles
 Use With: 1840 header as a board-to-board connector
 (contact Molex for details)

Electrical

Voltage: 250V
 Current: 5.0A max.
 Contact Resistance: 10 milliohms max.

Mechanical

Mating Force: 15.6N max.
 Unmating Force: 6.7N min.
 Mating Cycles: 25

Physical

Housing: Polyester, UL 94V-0
 Contact: Male—Brass, Female—Phosphor Bronze
 Plating: Tin

Circuits	Order No.	Terminal Pattern				Lead-free
		1	2	3	4	
3	10-18-1031	M	B	M		Yes
	10-18-1032	M	M	M		
	10-18-1033	F	M	M		
	10-18-1034	M	F	M		
	10-18-1035	M	M	F		
	10-18-1036	M	F	B		
	10-18-1037	M	F	F		
	10-18-1038	F	F	F		
	50-29-1031	B	B	B		
	4	10-18-1041	M	M	M	
10-18-1042		F	F	F	F	
10-18-1043		F	M	M	M	
10-18-1044		M	F	F	F	
10-18-1045		M	M	F	F	
10-18-1046		M	M	M	F	
10-18-1047		M	F	M	M	
10-18-1048		M	M	F	M	
10-18-1049		M	F	M	F	
10-18-1050		F	F	M	M	
10-18-1040		F	M	B	B	
50-29-1041	B	B	B	B		

M = Male terminal, F = Female terminal, B = Blank, no terminal

Circuits	Order No.	Terminal Pattern															Lead-free
		1	2	3	4	5	6	7	8	9	10	11	12	13	14	15	
6	10-18-1061	M	M	M	M	M	M										Yes
	10-18-1063	M	F	M	M	F	M										
	38-00-0589	F	M	M	M	F	M										
	38-00-0590	M	M	M	F	M	M										
	10-18-1064	M	M	M	M	M	F										
	10-18-1065	F	M	M	M	M	M										
	50-29-1061	B	B	B	B	B	B										
	9	10-18-1090	M	M	M	M	M	M	M	M	M						
50-29-1409		B	B	B	B	B	B	B	B	B							
12	10-18-1120	M	M	M	M	M	M	M	M	M	M	M					
	50-29-1412	B	B	B	B	B	B	B	B	B	B	B					
15	10-18-1150	M	M	M	M	M	M	M	M	M	M	M	M	M	M		
	50-29-1415	B	B	B	B	B	B	B	B	B	B	B	B	B	B		

Order No. for Loose Terminals	
Male	16-06-0002
Female	43080-0001

Assembly Tooling*	
Description	Order No.
Arbor Press with Universal Tool Kit	11-20-1172

* Used for assembling blank housings and loose terminals

E

Power Connectors

6.71mm (.264") Pitch .093" Pin and Socket Crimp Terminal Housing Receptacle

3191

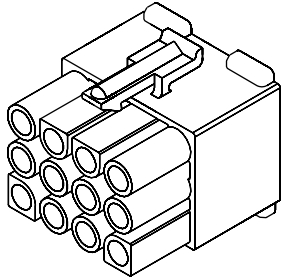

Features and Benefits

- Positive lock
- Fully isolated terminals
- Polarized housing assures proper mating
- Male and female terminals may be used in receptacle housing

Reference Information

UL File No.: E29179
CSA File No.: LR19980
TUV License No.: R75107
Mates With: 5219 header and 3191 plug
Use With: Standard .093" terminal

Electrical

Voltage: 600V
Current: 12.0A max.*

Mechanical

Contact Retention to Housing: 20 lb min.

Physical

Housing: Nylon, UL 94V-0 or 94V-2

* Depending on circuit size and wire gauge; please refer to product specifications

E
Power Connectors

Circuits	Order No.		Amperes per Circuit
	94V-2	94V-0	
1	19-09-1019	19-09-1016	12
2	19-09-1029	19-09-1026	
3	19-09-1039	19-09-1036	
4	19-09-1049	19-09-1046	9
6	19-09-1069	19-09-1066	
9	19-09-1099	19-09-1096	
12	19-09-1129	19-09-1126	
15	19-09-1159	19-09-1156	

6.71mm (.264") Pitch .093" Pin and Socket Crimp Terminal Housing Plug

3191

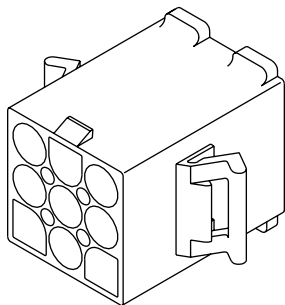

Features and Benefits

- Positive lock
- Fully isolated terminals
- Polarized housing assures proper mating
- Male and female terminals may be used in plug housing

Reference Information

UL File No.: E29179
CSA File No.: LR19980
TUV License No.: R75107
Mates With: 3191 receptacle
Use With: Standard .093" terminal

Electrical

Voltage: 600V
Current: 12.0A max.*

Mechanical

Contact Retention to Housing: 20 lb min.

Physical

Housing: Nylon, UL 94V-0 or 94V-2

* Depending on circuit size and wire gauge; please refer to product specifications

Circuits	Order No.				Amperes per Circuit
	Panel Mount		Free Hanging		
	94V-2	94V-0	94V-2	94V-0	
1	19-09-2018	19-09-2017	19-09-2019	19-09-2016	12
2	19-09-2028	19-09-2027	19-09-2029	19-09-2026	
3	19-09-2038	19-09-2037	19-09-2039	19-09-2036	
4	19-09-2048	19-09-2047	19-09-2049	19-09-2046	9
6	19-09-2068	19-09-2067	19-09-2069	19-09-2066	
9	19-09-2098	19-09-2097	19-09-2099	19-09-2096	
12	19-09-2128	19-09-2127	19-09-2129	19-09-2126	
15	19-09-2158	19-09-2157	19-09-2159	19-09-2156	

6.71 mm (.264") Pitch .093" Pin and Socket Header

5219

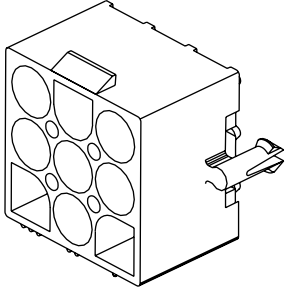

Features and Benefits

- Positive lock
- Fully isolated terminals
- Polarized housing assures proper mating

Reference Information

UL File No.: E29179
 CSA File No.: LR19980
 TUV License No.: R75107
 Mates With: 3191 receptacle

Electrical

Voltage: 600V
 Current: 12.0A max.*

Physical

Housing: Nylon, UL 94V-2
 Contact: Brass
 Plating: Tin
 *See product specification

Circuits	Order No.	Amperes per Circuit	Lead-free
2	15-31-1026	12	Yes
3	15-31-1036	11	
4	15-31-1046	9	
6	15-31-1066		
9	15-31-1096		

2.13mm (.084") Diameter MLX™ Pin and Socket Female Crimp Terminal 42024

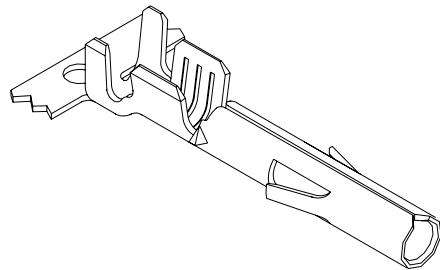

Features and Benefits

- Cross tested to assure industry compatibility
- Can be terminated with Molex or commercially available terminating equipment
- Split pin (male) for reduced mating forces

Reference Information

Product Specification: PS-42022-0001
UL File No.: E29179
CSA File No.: LR19980
Use With: 42021 and 42022 housings

Electrical

Voltage: 600V
Current: 13.5A*
Contact Resistance: 3.5 milliohms max.

Mechanical

Contact Insertion Force: 8.92N (2 lb)
Mating Force: 6.68N (1.5 lb) max.
Unmating Force: 4.46 (0.5 lb) min.
Mating Cycles: Tin plating—25 mating/unmating cycles
Gold plating—50 mating/unmating cycles

Physical

Contact: Brass or Phosphor Bronze
Plating: Tin

*See product specification

Type	Plating	Wire Size AWG	Insulation Diameter	Series	Socket		Lead-free
					Reel Form	Bag Form	
Standard Brass .012"	Tin	14-20	1.52 (.060) min. 3.30 (.130) max.	42024	02-08-1001	02-08-1002	Yes
Phosphor Bronze .012"					02-08-1003	02-08-1004	

2.13mm (.084") Diameter MLX™ Pin and Socket Male Crimp Terminal 42023

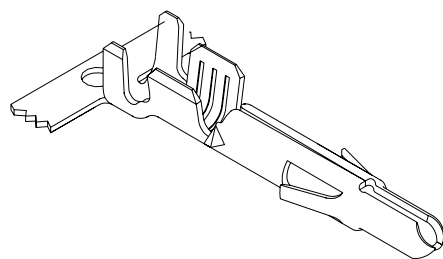

Features and Benefits

- Cross tested to assure industry compatibility
- Can be terminated with Molex or commercially available terminating equipment
- Split pin (male) for reduced mating forces

Reference Information

Product Specification: PS-42022-0001
UL File No.: E29179
CSA File No.: LR19980
Use With: 42021 and 42022 housings

Electrical

Voltage: 600V
Current: 13.5A*
Contact Resistance: 3.5 milliohms max.

Mechanical

Contact Insertion Force: 8.92N (2 lb)
Mating Force: 6.68N (1.5 lb) max.
Unmating Force: 4.46 (0.5 lb) min.
Mating Cycles: Tin plating—25 mating/unmating cycles
Gold plating—50 mating/unmating cycles

Physical

Contact: Brass or Phosphor Bronze
Plating: Tin

*See product specification

Type	Plating	Wire Size AWG	Insulation Diameter	Series	Split Pin		Lead-free
					Reel Form	Bag Form	
Standard Brass .012"	Tin	14-20	1.52 (.060) min. 3.30 (.130) max.	42023	02-08-2003	02-08-2004	Yes
Phosphor Bronze .012"					02-08-2005	02-08-2006	

2.13mm (.084") Diameter MLX™ Pin and Socket Crimp Terminal Housing Receptacle

42022

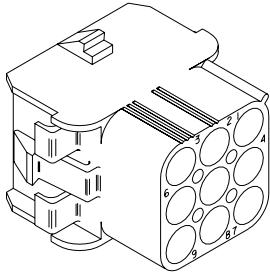

Features and Benefits

- Intermateable, intermountable and interchangeable with industry-standard versions
- Cross tested to assure industry compatibility
- Positive locks
- Fully isolated contacts
- Circuit ID grooves to reduce assembly errors
- Anti-stress positioning tabs to reduce breakage

Reference Information

Product Specification: PS-42022-0001
UL File No.: E29179
CSA File No.: LR19980

Electrical

Voltage: 600V
Current: See product specification for detail

Circuits							
1	2	3	4	6	9	12	15
13.5A	13.5A	13.5A	13.5A	11.0A	11.0A	11.0A	11.0A

Mechanical

Contact Retention to Housing: 66.88N (15 lb)

Physical

Cap Housing: Nylon, 94V-2 or 94V-0

Circuits	Order No.		
	94V-2 (White)	94V-0 (Brick Red)	94V-0 (White)
1	50-84-2010	50-84-2011	50-84-2012
2	50-84-2020	50-84-2021	50-84-2022
3	50-84-2030	50-84-2031	50-84-2032
4	50-84-2040	50-84-2041	50-84-2042
6	50-84-2060	50-84-2061	50-84-2062
9	50-84-2090	50-84-2091	50-84-2092
12	50-84-2120	50-84-2121	50-84-2122
15	50-84-2150	50-84-2151	50-84-2152

Cap housing should be installed into panel in the same direction as the panel cutout is punched

2.13mm (.084") Diameter MLX™ Pin and Socket Crimp Terminal Housing Plug

42021

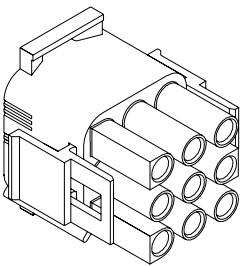

Features and Benefits

- Intermateable, intermountable and interchangeable with industry-standard versions
- Cross tested to assure industry compatibility
- Positive locks
- Fully isolated contacts
- Circuit ID grooves to reduce assembly errors
- Anti-stress positioning tabs to reduce breakage

Reference Information

Product Specification: PS-42022-0001
UL File No.: E29179
CSA File No.: LR19980
Mates With: 42002 header, 42022 cap and 43255 header

Electrical

Voltage: 600V
Current: See product specification for detail

Circuits							
1	2	3	4	6	9	12	15
13.5A	13.5A	13.5A	13.5A	11.0A	11.0A	11.0A	11.0A

Dielectric Withstanding Voltage: 2900V (Header),
5000V (Wire-To-Wire)
Insulation Resistance: 1000 Megohms min.

Mechanical

Contact Retention to Housing: 66.88N (15 lb)

Physical

Plug Housing: Nylon, 94V-2 or 94V-0

Circuits	Amperes/Circuit (Max.)	Order No.		
		94V-2 (White)	94V-0 (Brick Red)	94V-0 (White)
1	13.5	50-84-1010	50-84-1011	50-84-1015
2		50-84-1020	50-84-1021	50-84-1025
3		50-84-1030	50-84-1031	50-84-1035
4		50-84-1040	50-84-1041	50-84-1045
6	11	50-84-1060	50-84-1061	50-84-1065
9		50-84-1090	50-84-1091	50-84-1095
12		50-84-1120	50-84-1121	50-84-1125
15		50-84-1150	50-84-1151	50-84-1155

2.13mm (.084") Diameter MLX™ Power Connector Header

42002
Vertical

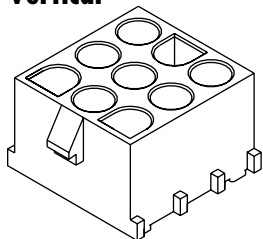

Features and Benefits

- Intermateable, intermountable and interchangeable with industry-standard versions
- Cross tested to assure industry compatibility
- Positive locks
- Fully isolated contacts

Reference Information

Product Specification: PS-42022-0001

UL File No.: E29179

CSA File No.: LR19980

Electrical

Voltage: 600V

Current: See product specification for detail

Circuits						
2	3	4	6	9	12	15
13.5A	13.5A	13.5A	11.0A	11.0A	11.0A	11.0A

Contact Resistance: 3.5 milliohms max.

Physical

Header Housing: See Table

Header Contact: Phosphor Bronze

Plating: Tin

E

Power Connectors

Circuits	Order No.				Housing	Lead-free
	White		Brick Red			
	Male	Female	Male	Female		
2	10-84-4020	10-84-4022			94V-2	Yes
	10-84-5020	10-84-5021	10-84-4021	10-84-4023	94V-0	
3	10-84-4030	10-84-4032			94V-2	
	10-84-5030	10-84-5031	10-84-4031	10-84-4033	94V-0	
4	10-84-4040	10-84-4042			94V-2	
	10-84-5040	10-84-5041	10-84-4041	10-84-4043	94V-0	
6	10-84-4060	10-84-4062			94V-2	
	10-84-5060	10-84-5061	10-84-4061	10-84-4063	94V-0	
9	10-84-4090	10-84-4092			94V-2	
	10-84-5090	10-84-5091	10-84-4091	10-84-4093	94V-0	
12	10-84-4120	10-84-4122			94V-2	
	10-84-5120	10-84-5121	10-84-4121	10-84-4123	94V-0	
15	10-84-4150	10-84-4152			94V-2	
	10-84-5150	10-84-5151	10-84-4151	10-84-4153	94V-0	

2.13mm (.084") Diameter MLX™ Power Connector Header

43255

Vertical
Polarizing Peg

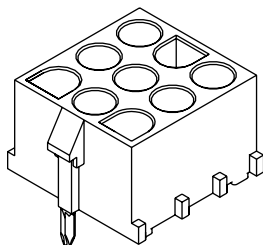

Features and Benefits

- Intermateable, intermountable and interchangeable with industry-standard versions
- Cross tested to assure industry compatibility
- Positive locks
- Fully isolated contacts

Reference Information

Product Specification: PS-42022-0001

UL File No.: E29179

CSA File No.: LR19980

Electrical

Voltage: 600V*

Current: See product specification for detail

Circuits						
2	3	4	6	9	12	15
13.5A	13.5A	13.5A	11.0A	11.0A	11.0A	11.0A

* Ratings are per circuit, based on fully loaded housings

Contact Resistance: 3.5 milliohms max.

Physical

Header Housing: See Table

Header Contact: Phosphor Bronze

Plating: Tin

Circuits	Order No.						Lead-free
	UL 94V-2		UL 94V-0				
	White		White		Brick Red		
	Male	Female	Male	Female	Male	Female	
2	43255-0113	43255-0115	43255-0059	43255-0003	43255-0001	43255-0057	Yes
3	43255-0121	43255-0123	43255-0067	43255-0011	43255-0009	43255-0065	
4	43255-0129	43255-0131	43255-0075	43255-0019	43255-0017	43255-0073	
6	43255-0137	43255-0139	43255-0083	43255-0027	43255-0025	43255-0081	
9	43255-0145	43255-0147	43255-0091	43255-0035	43255-0033	43255-0089	
12	43255-0153	43255-0155	43255-0099	43255-0043	43255-0041	43255-0097	
15	43255-0161	43255-0163	43255-0107	43255-0051	43255-0049	43255-0105	

6.50mm (.256") Pitch Wire-to-Board Crimp Terminal 50597/50598 Female

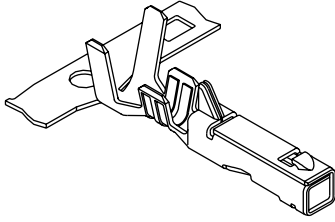

Order No.	Packaging	Lead-free
50597-8000	Reel	Yes
50598-8000		
50597-8100		
50598-8100	Bag	

Features and Benefits

- Locking tang provides guide for retainer
- Housing lance holds terminal firmly in place

Reference Information

Use With: 51142
Designed In: Millimeters

Electrical

Voltage: 600V max.
Current: 10.0A max.

Physical

Contact: Copper Alloy
Plating: Tin
Wire Range: 50597—16 to 22 AWG
50598—20 to 26 AWG

Insulation Range:

50597—2.00 to 3.30mm dia.

Note: When using retainer—2.50mm dia. max.

50598—1.25 to 2.35mm dia.

Strip Length: 2.70 to 3.30mm

www.molex.com/customer.html?seriesNumber=50597

6.50mm (.256") Pitch Wire-to-Board Receptacle 51142

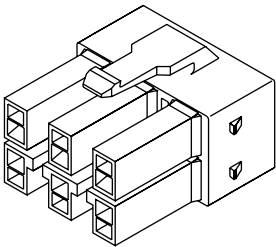

Circuits	Order No.
2	51142-0200
4	51142-0400
6	51142-0600

Features and Benefits

- Sizes 2, 4 and 6 circuits
- Inner positive lock provides easy attachment and secure mating retention
- Polarizing guide walls

Reference Information

Product Specification: PS-51142-003
Packaging: Bag
UL File No.: E29179
CSA File No.: LR19980
Mates With: 53721 and 53728
Use With: 50597 and 50598
Applicable Retainer: 51143
Designed In: Millimeters

Electrical

Voltage: 600V max.
Current: 10.0A max.
Contact Resistance: 10 milliohms max.
Dielectric Withstanding Voltage: 1500V AC/1 min.
Insulation Resistance: 1000 Megohms min.

Physical

Housing: PBTP, UL 94V-0

6.50mm (.256") Pitch Wire-to-Board Header

53728

Vertical with Peg

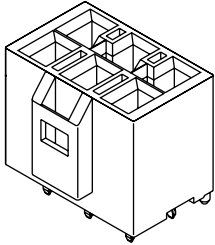

Circuits	Order No.	Lead-free
2	53728-0219	Yes
4	53728-0419	
6	53728-0619	

Features and Benefits

- Sizes 2, 4 and 6 circuits
- Inner positive lock provides easy attachment and secure mating retention
- Stand-offs prevent flux wicking
- Locating peg for placement guidance and polarization

Reference Information

Product Specification: PS-51142-003
 Packaging: Tray
 UL File No.: E29179
 CSA File No.: LR19980
 Mates With: 51142
 Designed In: Millimeters

Electrical

Voltage: 600V max.
 Current: 10.0A max.
 Contact Resistance: 10 milliohms max.
 Dielectric Withstanding Voltage: 1500V AC/1 min.
 Insulation Resistance: 1000 Megohms min.

Physical

Housing: Glass-filled Nylon, UL 94V-0
 Contact: Copper Alloy
 Plating: Tin over Nickel

www.molex.com/customer.html?seriesNumber=53728

6.50mm (.256") Pitch Wire-to-Board Header

53721

Vertical With Snap-Fit Pegs

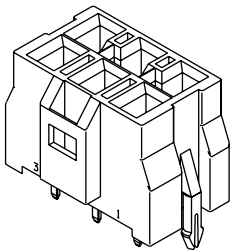

Circuits	Order No.	Lead-free
2	53721-0270	Yes
4	53721-0470	
6	53721-0670	

Features and Benefits

- Sizes 2, 4 and 6 circuits
- Inner positive lock provides easy attachment and secure mating retention
- Stand-offs prevent flux wicking
- Snap-fit pegs for secure PCB retention
- Side walls protect PCB peg

Reference Information

Product Specification: PS-51142-003
 Packaging: Tray
 Mates With: 51142
 Designed In: Millimeters

Electrical

Voltage: 600V max.
 Current: 10.0A max.
 Contact Resistance: 10 milliohms max.
 Dielectric Withstanding Voltage: 1500V AC/1 min.
 Insulation Resistance: 1000 Megohms min.

Physical

Housing: Glass-filled Nylon, UL 94V-0
 Contact: Copper Alloy
 Plating: Tin over Nickel

Mini-Fit® General Overview

Mini-Fit Jr.™

The Mini-Fit Jr. was specifically developed for positive locking, wire-to-wire and wire-to-board applications. It is available in single row and dual row versions. The system offers the widest range of circuit sizes.

Mini-Fit BMI™

For blind-mating applications, the Mini-Fit BMI was introduced. The receptacle housing is self-aligning and will move up to 0.050" in the x and y axes, when properly installed in a panel. The system is suitable for panel-to-panel, panel-to-board or board-to-board applications. It features wave-solderable headers, reflow-solderable headers and press-fit headers.

Mini-Fit TPA™

This version of the Mini-Fit family was uniquely designed to assure that the terminals are fully seated in the receptacle and plug housings and cannot back out. The system is for positive locking, wire-to-wire and wire-to-board applications.

Mini-Fit Plus HCS™

The Mini-Fit Plus HCS was designed for high current applications as it is capable of handling current loads of as much as 12.0A. The gold-plated terminals and headers are hot-pluggable; i.e., ideal for applications that require hot mating and unmating of connectors. This is the most flexible Mini-Fit system since it is offered in Mini-Fit Jr, Mini-Fit BMI and Mini-Fit TPA design formats.

Mini-Fit Plus HMC™

The Mini-Fit Plus High Mating Cycle specializes in applications that require hundreds of mating cycles. It is also blind-mating. Solutions for panel-to-panel, panel-to-board and board-to-board applications exist.

Mini-Fit RTC™

Mini-Fit RTC, reflow temperature capable headers were designed for use in lead free processing environments. They are made from high temperature LCP and mate with standard Mini-Fit Jr. receptacles.

Mini-Fit H2O

The Mini-Fit H2O is IP 67 rated for waterproof applications. The housings are made from a UV stable material making them suitable for outdoor applications. Mini-Fit H2O has integral seals that keep moisture and dust out. Seals are preinstalled by Molex to lower applied costs.

Family	Description	Current Rating (Smallest Circuit)	Current Rating (Largest Circuit)	Housing Lock	Configurations	Agency Approvals	Circuit Sizes	Wire Gauge	Flammability
Mini-Fit Plus HCS	Mini-Fit Plus HCS (High Current System) is capable of carrying up to 12A per circuit. The terminals fit in all Mini-Fit Jr, BMI, and TPA plugs and receptacles.	12A [†]	11A [†]	Positive or None	W-to-W W-to-B B-to-B	Pending	2, 3, 4, 5, 6, 8, 10, 12, 14, 16, 18, 20, 22, 24	16, 18-20	94V-0
Mini-Fit Plus HMC	Mini-Fit Plus HMC (High Mating Cycle) is capable of being mated and unmated hundreds of times and still able to provide reliable electrical connections. It is available only in the BMI format.	9A [§]	6A [§]	None	W-to-W W-to-B B-to-B	Pending	4, 6, 10, 14, 18, 24	16, 18-20, 22-24	94V-0
Mini-Fit Jr.	Mini-Fit Jr connectors are suitable for positive locking high current/high density applications.	9A [†]	6A [†]	Positive	W-to-W W-to-B	UL CSA TUV	2, 3, 4, 5, 6, 8, 10, 12, 14, 16, 18, 20, 22, 24	16, 18-20, 22-24	94V-2, 94V-0
Mini-Fit TPA	Mini-Fit TPA (Terminal Position Assurance) connectors assure the terminals are fully seated in their housing and cannot back out for added reliability.	9A [†]	6A [†]	Positive	W-to-W W-to-B	UL CSA TUV	2, 4, 6, 8, 10, 12, 16	16, 18-20, 22-24	94V-0
Mini-Fit BMI	Mini-Fit BMI (Blindmate Interface) connectors are designed for applications that require blind-mating of PCBs, daughtercards, or subassemblies.	9A [†]	6A [†]	None	W-to-W W-to-B B-to-B	UL CSA TUV	4, 6, 10, 14, 18, 24	16, 18-20, 22-24	94V-2, 94V-0
Mini-Fit BMI (SMC)	Mini-Fit BMI (SMC) are surface mount compatible headers suitable for high temperature reflow processes. They mate to the standard Mini-Fit BMI crimp receptacle or PCB receptacle to allow blind mating.	9A [†]	6A [†]	None	W-to-W W-to-B B-to-B	UL CSA TUV	4, 6, 10, 14, 18, 24	16, 18-20, 22-24	94V-0
Mini-Fit BMI (CPI)	Mini-Fit BMI (CPI) are press fit vertical headers suitable for high temperature reflow processes. They mate to the standard Mini-Fit BMI crimp receptacle or PCB receptacle to allow blind mating.	7A [†]	5A [†]	None	W-to-W W-to-B B-to-B	UL CSA TUV	4, 6, 10, 14, 18, 24	16, 18-20, 22-24	94V-0
Mini-Fit PCIe	Mini-Fit PCIe connectors feature a unique polarization scheme so they are suitable for PCI Express™ high end graphic card applications only.	8A ^{**}	8A ^{**}	Positive	W-to-B	None	6	16, 18-24, 22-28	94V-0
Mini-Fit RTC	Mini-Fit RTC headers can withstand high temperature solder processes. Compatible with lead free solder processes.	12.0A	11.0A	Positive	W-to-B	Pending	4, 6, 8, 10, 12, 24	16, 18-20, 22-24	94V-0
Mini-Fit H2O	Mini-Fit H2O is IP 67 rated for weatherproof, waterproof applications.	9.0A	9.0A	Positive	W-to-W	Pending	2	18-20	94V-0

[†]Mini-Fit Plus Crimp Terminals: 46083 (Female) and 46134 (Male)

[‡]Mini-Fit Plus HCS Crimp Terminals: 45750 (Female) and 46012 (Male)

[§]Mini-Fit High Cycle Crimp Terminals: 46018 (Female) and 46098 (Male)

^{**}Mini-Fit Crimp Terminals: 5556 (Female)

*Note: PCI Express is a registered trademark of the Peripheral Component Interchange Special Interest Group (PCI-SIG).

4.20mm (.165") Pitch Mini-Fit Jr™ Connector System

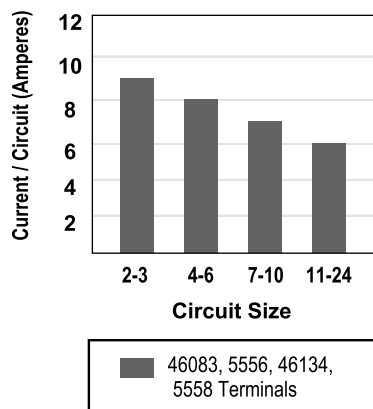

Features

- Positive Locking**
 Receptacle housing is equipped with a locking thumb latch. Each plug housing or header features a locking ramp. When mated, the latch and ramp prevent the connectors from accidental unmating.
- Configurations**
 The receptacle housings, plug housings and headers allow designs for wire-to-wire or wire-to-board applications.
- Polarized Mating Geometry**
 The receptacle housings and PCB receptacles are polarized with the plug housings and headers to minimize the chance of mismatching the connectors.
- Polarizing Pegs**
 Optional polarizing pegs orient the headers on the PCB so they are not inserted backwards and then hold the headers to the PCB during the wave soldering process.
- Lead-free**
 Mini-Fit Jr connectors are lead-free.
- MFBL**
 Molex offers make first, break last header options

Specifications

Current Rating: 9.0A max. (16 AWG wire)
 Voltage Rating: 600V
 Contact Resistance:
 10 milliohms max. (initial)
 Wire Range:
 16 AWG
 18 to 20 AWG
 22 to 24 AWG
 Plating Options: Tin or Select Gold
 Housing Material: 6/6 nylon, UL 94V-2 or UL 94V-0
 Agency Approvals: UL, CSA, TUV

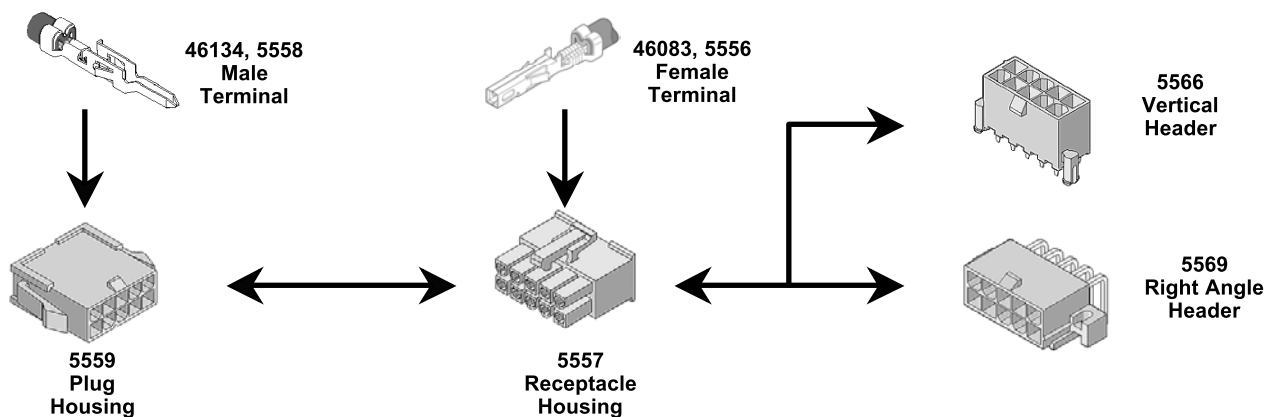
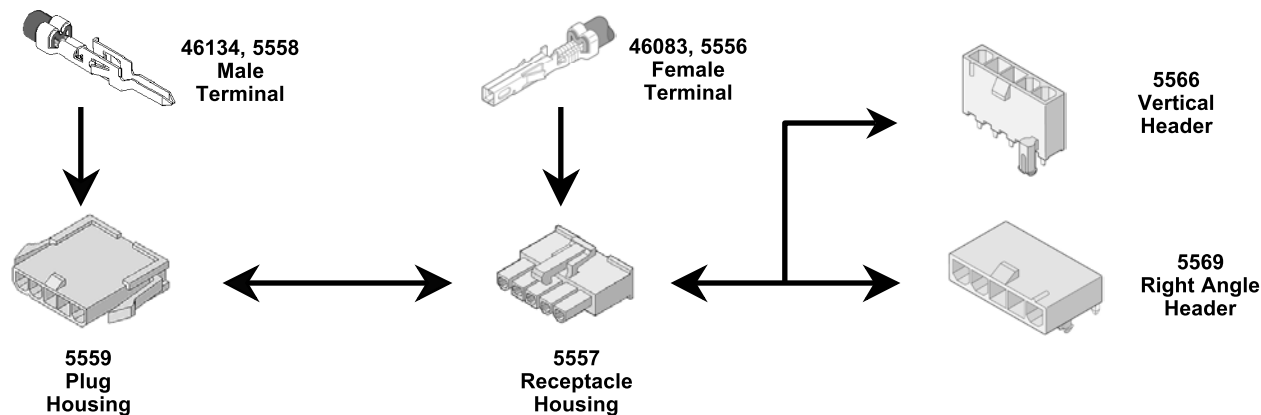

4.20mm (.165") Pitch Mini-Fit Plus™ Terminal

46083
Crimp, Female

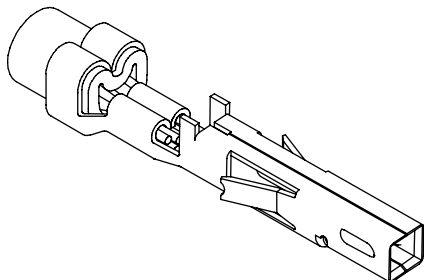

Features and Benefits

- Post-plated contacts for superior electrical performance over time
- Reliable elongated dimple which provides full and consistent engagement between female box terminal and male pin

Reference Information

Product Specification: PS-46083-001
Application Specifications: ATS-639002600
ATS-639002800

UL File No: E29179
CSA File No: LR19980
TUV License No: R75142
Use With: 5557, 30067, 42474 and 44516 receptacles

Electrical

Current: 10.0 max. (See applicable product specification.)
Voltage: 600V
Contact Resistance: 10 milliohms max.

Mechanical

Mating Force: 14.7N max. per contact
Unmating Force: 1.0N min. per contact
Normal Force: 0.49N min. per contact
Mating Cycles: Tin—30 cycles
Gold—100 cycles

Physical

Contact Material: Brass or Phosphor Bronze
Wire Size: 16-24 AWG (See Product and Application Tooling specifications for complete crimping guidelines.)

Base Material	Plating	Wire Range AWG	Reel	Bag	Lead-free
Brass	Tin	16	46083-3111	46083-3112	Yes
		18-20	46083-1111	46083-1112	
		22-24	46083-2111	46083-2112	
	30µl" Select Gold	16	46083-3211	46083-3212	
		18-20	46083-1211	46083-1212	
		22-24	46083-2211	46083-2212	
Phosphor Bronze	Tin	16	46083-3121	46083-3122	
		18-20	46083-1121	46083-1122	
		22-24	46083-2121	46083-2122	
	30µl" Select Gold	16	46083-3221	46083-3222	
		18-20	46083-1221	46083-1222	
		22-24	46083-2221	46083-2222	

4.20mm (.165") Pitch Mini-Fit® Family Terminal

5556
Crimp, Female

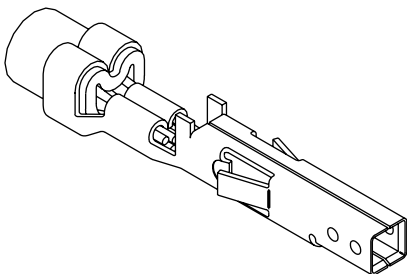

Features and Benefits

- Four gas-tight points of contact

Reference Information

Product Specification: PS-5556-001
Application Specifications: ATS-639002600
ATS-639002800

UL File No: E29179
CSA File No: LR19980
TUV License No: R75142
Use With: 5557, 30067, 42474 and 44516 receptacles

Electrical

Current: 9.0 max. (See applicable product specification.)
Voltage: 600V
Contact Resistance: 10 milliohms max.

Mechanical

Mating Force: 14.7N max. per contact
Unmating Force: 1.0N min. per contact
Normal Force: 0.49N min. per contact
Mating Cycles: 30 cycles

Physical

Contact Material: Brass or Phosphor Bronze
Wire Size: 16-24 AWG (See Product and Application Tooling specifications for complete crimping guidelines.)

Contact Material	Wire Size (AWG)	Plating	Order No. 5556		Lead-free
			Reel	Bag	
Brass	16	Tin	39-00-0077	39-00-0078	Yes
	18-24		39-00-0038	39-00-0039	
Phosphor Bronze	16		39-00-0079	39-00-0080	
	18-24		39-00-0059	39-00-0060	

4.20mm (.165") Pitch Mini-Fit Plus™ Terminal

46134
Crimp, Male

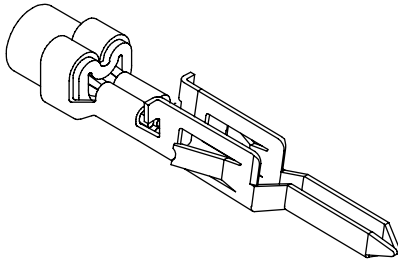

Features and Benefits

- Post-plated contacts for superior electrical performance over time
- Locking tangs assure high contact retention to the housing

Reference Information

Product Specification: PS-46083-001
Application Specifications: ATS-639002600
ATS-639002800

UL File No: E29179
CSA File No: LR19980
TUV License No: R75142
Use With: 5559, 42475 and 30068 plug housings

Electrical

Current: 10.0A max. (See applicable product specification.)
Voltage: 600V
Contact Resistance: 10 milliohms max.

Mechanical

Mating Force: 14.7N max. per contact
Unmating Force: 1.0N max. per contact
Normal Force: 0.49N min. per contact
Mating Cycles: Tin—30 cycles
Gold—100 cycles

Physical

Contact Material: Brass or Phosphor Bronze
Wire Size: 16-24 AWG (See Product and Application Tooling specifications for complete crimping guidelines.)

Base Material	Plating	Wire Range AWG	Reel	Bag	Lead-free
Brass	Tin	16	46134-3111	46134-3112	Yes
		18-20	46134-1111	46134-1112	
		22-24	46134-2111	46134-2112	
	30µ" Select Gold	16	46134-3211	46134-3212	
		18-20	46134-1211	46134-1212	
		22-24	46134-2211	46134-2212	
Phosphor Bronze	Tin	16	46134-3121	46134-3122	
		18-20	46134-1121	46134-1122	
		22-24	46134-2121	46134-2122	
	30µ" Select Gold	16	46134-3221	46134-3222	
		18-20	46134-1221	46134-1222	
		22-24	46134-2221	46134-2222	

4.20mm (.165") Pitch Mini-Fit® Family Terminal

5558
Crimp, Male

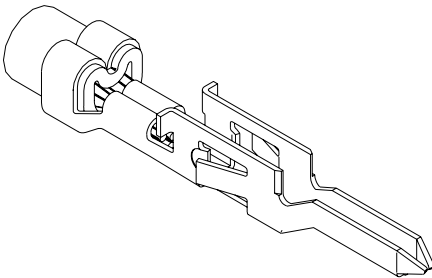

Features and Benefits

- Crimp terminal for use in all Mini-Fit, Jr., BMI and TPA plug housings

Reference Information

Product Specification: PS-5556-001
Application Specifications: ATS-639002600
ATS-639002800

UL File No: E29179
CSA File No: LR19980
TUV License No: R75142
Use With: 5559, 42475 and 30068 plug housings

Electrical

Voltage: 600V
Current: 9.0A max.
Contact Resistance: 10 milliohms max.

Mechanical

Mating Force: 14.7N max. per contact
Unmating Force: 1.0N max. per contact
Normal Force: 0.49N min. per contact
Mating Cycles: 30 cycles

Physical

Contact Material: Brass or Phosphor Bronze (See applicable product specification.)
Wire Size: 16-24 AWG (See Product and Application Tooling specifications for complete crimping guidelines.)

Contact Material	Wire Size (AWG)	Plating	Order No.		Lead-free
			Reel	Bag	
Brass	16	Tin	39-00-0081	39-00-0082	Yes
	18-24		39-00-0040	39-00-0041	
Phosphor Bronze	16		39-00-0083	39-00-0084	
	18-24		39-00-0061	39-00-0062	

4.20mm (.165") Pitch Mini-Fit Jr.™ Crimp Terminal Receptacle

5557
Single Row

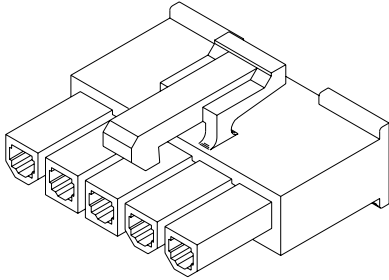

Circuits	Order No.	
	94V-2	94V-0
3*	39-01-4030	39-01-4031
4	39-01-4040	39-01-4041
5	39-01-4050	39-01-4051

*3-circuit receptacle designed for first-mate/last-break applications

Features and Benefits

- Low profile design to accommodate height constraints
- Fully isolated terminals to protect contacts from damage
- For wire-to-wire or wire-to-board applications

Reference Information

Product Specification: PS-5556-001
 UL File No: E29179
 CSA File No: LR19980
 TUV License No: R75142
 Mates With: 5559, 5566 and 5569 single row connectors
 Use With: 5556, 46083 or 45750 terminals

Electrical

See Crimp Terminal page.

Mechanical

Locking: Positive

Physical

Housing: 6/6 nylon, UL 94V-2 or 94V-0

4.20mm (.165") Pitch Mini-Fit Jr.™ Crimp Terminal Housing Plug

5559
Single Row, with and
Without Panel Mount Ears

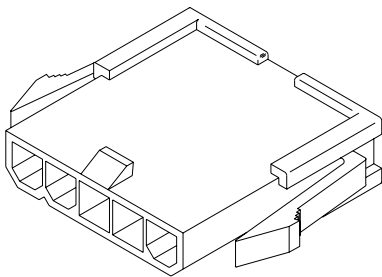

Features and Benefits

- Wire-to-wire plug for panel-mounted or free-hanging applications
- Available with and without panel mounting ears
- Positive housing locks to mate with Mini-Fit Jr. receptacle
- Fully isolated terminals to protect contacts from damage

Reference Information

Product Specification: PS-5556-001
 UL File No.: E29179
 CSA File No.: LR19980
 TUV License No.: R75142
 Mates With: 5557 single row receptacles
 Use With: 5558, 30490, 46134 or 46012 terminals
 Panel Thickness: .079 to 2.00mm (.031 to 0.80")

Electrical

See Crimp Terminal page.

Mechanical

Locking: Positive

Physical

Housing: 6/6 nylon, UL 94V-2 or 94V-0

Circuits	Order No.			
	Panel Mount		Free Hanging	
	94V-2	94V-0	94V-2	94V-0
3*	39-01-4032	39-01-4033	39-01-4036	39-01-4037
4			39-01-4046	39-01-4047
5	39-01-4052	39-01-4053	39-01-4056	39-01-4057

*3-circuit plug designed for first-mate/last-break applications

4.20mm (.165") Pitch Mini-Fit Jr.™ Header

5566

Vertical, Single Row With Pegs

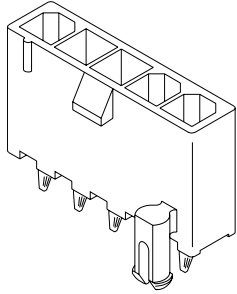

Features and Benefits

- Positive housing locks to mate with Mini-Fit Jr. single row receptacle
- Fully isolated terminals to protect contacts from damage
- Peg-mounted vertical headers for increased board retention
- Drain holes are standard to allow washing of PCB after processing (contact Molex for headers without drain holes)

Reference Information

Product Specification: PS-5556-001
 UL File No: E29179
 CSA File No: LR19980
 TUV License No: R75142
 Mates With: 5557 Single row receptacles
 Use With: 5556 and 46083 terminals

Electrical

Current: 9.0A max. (See applicable product specification.)
 Voltage: 600V
 Contact Resistance: 10 milliohms max.

Mechanical

Mating Cycles: 30 cycles

Physical

Housing: 6/6 nylon, UL 94V-2 or 94V-0
 Contact Material: Brass

Circuits	Order No.				Tail Length	Lead-free
	Tin Plated		Select Gold Plated (30µ")			
	94V-2	94V-0	94V-2	94V-0		
3	39-30-5039	39-30-6030	39-30-2037	39-30-2038	3.5mm (0.14")	Yes
4	39-30-5049	50-30-4466	39-30-2047	39-30-2048		
5		50-30-4467		39-30-2058		

4.20mm (.165") Pitch Mini-Fit Jr.™ Header

5569

Right Angle, Single Row With Flanges

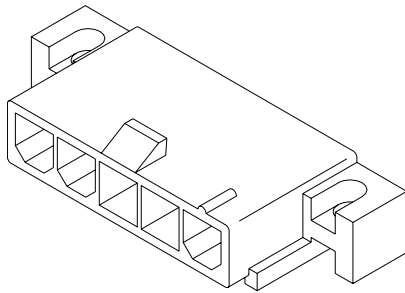

Features and Benefits

- Flanges allow for screw-in retention to board-mounted headers
- Low profile is ideal for power applications with space constraints

Reference Information

Product Specification: PS-5556-001
 UL File No.: E29179
 CSA File No.: LR19980
 TUV License No.: R75142
 Mates With: 5557 single row receptacle
 Use With: 5556, 46083 and 45750 terminals

Electrical

Current: 12.0A max. (See applicable product specification.)
 Voltage: 600V
 Contact Resistance: 10 milliohms max.

Mechanical

Mating cycles: 30 cycles

Physical

Housing: 6/6 nylon, UL 94V-2 or 94V-0
 Contact Material: Brass

Circuits	Order No.				Tail Length	Lead-free
	Tin Plated		Select Gold Plated			
	94V-2	94V-0	94V-2	94V-0		
3	39-30-6039	39-30-7030	39-30-4037	39-30-4038	3.6mm	Yes
4	39-30-6049		50-30-4443			

4.20mm (.165") Pitch Mini-Fit Jr.™ Header

5569

Right Angle, Single Row With Pegs

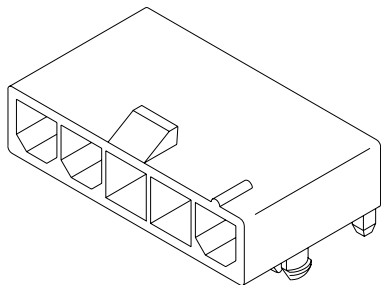

Features and Benefits

- Pegs provide increased board retention
- Ideal for low profile power applications
- Positive housing locks to mate with Mini-Fit Jr. single row receptacles
- Fully isolated terminals to protect contacts from damage

Reference Information

Product Specification: PS-5556-001
UL File No.: E29179
CSA File No.: LR19980
TUV License No.: R75142
Mates With: 5557 single row receptacles
Use With: 5556, 46083 and 45750 terminals

Electrical

Current: 12.0A max. (See applicable product specification.)
Voltage: 600V
Contact Resistance: 10 milliohms max.

Mechanical

Mating cycles: 30 cycles

Physical

Housing: 6/6 nylon, UL 94V-2 or 94V-0
Contact Material: Brass

Circuits	Order No.				Tail Length	Lead-free
	Tin Plated		Select Gold Plated			
	94V-2	94V-0	94V-2	94V-0		
3	39-30-7031	39-30-7032	39-30-4031	39-30-4032	3.6mm	Yes
4	39-30-7041	39-30-7042	50-30-4438	50-30-4441		
5	39-30-7051	39-30-7052	50-30-4439	50-30-4442		

4.20mm (.165") Pitch Mini-Fit Jr.™ Crimp Terminal Housing Receptacle

5557

Dual Row

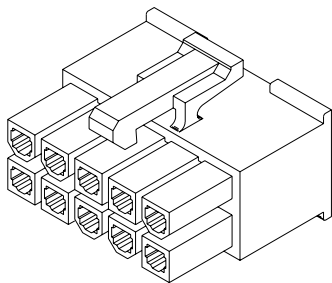

Features and Benefits

- Positive housing lock for secure mating retention
- Fully isolated terminals to protect contacts from damage
- Thumbblatch for easy unmating

Reference Information

Product Specification: PS-5556-001
UL File No.: E29179
CSA File No.: LR19980
TUV License No.: R75142
Mates With: 5559, 5566, 5569, 42404, 42440, 42475, 43810, 43879 and 44068 dual row connectors
Use With: 5556, 46083 or 45750 terminals

Electrical

See Crimp Terminal page.

Mechanical

Locking: Positive

Physical

Housing: 6/6 nylon, UL 94V-2 or 94V-0

Circuits	Order No.		Circuits	Order No.	
	94V-2	94V-0		94V-2	94V-0
2	39-01-2020	39-01-2025	14	39-01-2140	39-01-2145
4	39-01-2040	39-01-2045	16	39-01-2160	39-01-2165
6	39-01-2060	39-01-2065	18	39-01-2180	39-01-2185
8	39-01-2080	39-01-2085	20	39-01-2200	39-01-2205
10	39-01-2100	39-01-2105	22	39-01-2220	39-01-2225
12	39-01-2120	39-01-2125	24	39-01-2240	39-01-2245

4.20mm (.165") Pitch Mini-Fit Jr.™ Crimp Terminal Housing Plug

5559
Dual Row
With and without Panel Mount Ears

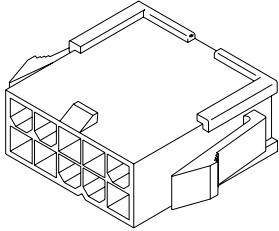

Features and Benefits

- Wire-to-wire plug for panel-mounted or free-hanging applications
- Positive housing locks to mate with Mini-Fit Jr. receptacle
- Fully isolated terminals to protect contacts from damage

Reference Information

Product Specification: PS-5556-001
UL File No.: E29179
CSA File No.: LR19980
TUV License No.: R75142
Mates With: 5557 dual row receptacle
Use With: 5558, 30490, 46134 or 46012 terminals
Panel Thickness: .079 to 2.00mm (.031 to 0.80")

Electrical

See Crimp Terminal page.

Mechanical

Locking: Positive

Physical

Housing: 6/6 nylon, UL 94V-2 or 94V-0

Circuits	Order No.			
	Panel Mount		Free Hanging	
	94V-2	94V-0	94V-2	94V-0
2	39-01-2021	39-01-2026	39-01-3023	39-01-3029
4	39-01-2041	39-01-2046	39-01-3043	39-01-3049
6	39-01-2061	39-01-2066	39-01-3063	39-01-3069
8	39-01-2081	39-01-2086	39-01-3083	39-01-3089
10	39-01-2101	39-01-2106	39-01-3103	39-01-3109
12	39-01-2121	39-01-2126	39-01-3123	39-01-3129
14	39-01-2141	39-01-2146	39-01-3143	39-01-3149
16	39-01-2161	39-01-2166	39-01-3163	39-01-3169
18	39-01-2181		39-01-3183	
20	39-01-2201			
22	39-01-2221			
24	39-01-2241	39-01-2246		

4.20mm (.165") Pitch Mini-Fit Jr.™ Header

5566
Vertical, Dual Row
With Pegs, with Drain Holes

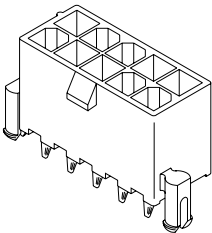

Features and Benefits

- Board-mounting pegs provide polarization during placement on the PCB and increased retention during soldering process
- Positive housing locks to mate with Mini-Fit Jr. receptacle
- Fully isolated terminals to protect contacts from damage
- Drain holes are standard to allow washing of PCB after processing (contact Molex for headers without drain holes)

Reference Information

Product Specification: PS-5556-001
UL File No.: E29179
CSA File No.: LR19980
TUV License No.: R75142
Mates With: 5557 dual row receptacle
Use With: 5556 and 46083 terminals

Electrical

Current: 19.0A max. (See applicable product specification.)
Voltage: 600V
Contact Resistance: 10 milliohms max.

Mechanical

Mating Cycles: 30 cycles

Physical

Housing: 6/6 nylon, UL 94V-2 or 94V-0
Contact Material: Brass

Circuits	Order No.				Tail Length	Lead-free
	Tin Plated		Gold Plated (30µ")			
	94V-2	94V-0	94V-2	94V-0		
2	39-30-6027	39-30-6028	39-29-9024	39-28-9028	3.5mm	Yes
4	39-30-6047	39-30-6048	39-29-9044	39-28-9048		
6	39-30-6067	39-30-6068	39-29-9064	39-28-9068		
8	39-30-6087	39-30-6088	39-29-9084	39-28-9088		
10	39-30-6107	39-30-6108	39-29-9104	39-28-9108		
12	39-30-6127	39-30-6128	39-29-9124	39-28-9128		
14	39-30-6147	39-30-6148	39-29-9144	39-28-9148		
16	39-30-6167	39-30-6168	39-29-9164	39-28-9168		
18	39-30-6187	39-30-6188	39-29-9184	39-28-9188		
20	39-30-6207	39-30-6208	39-29-9204	39-28-9208		
22	39-30-6227	39-30-6228	39-29-9224			
24	39-30-6247	39-30-6248	39-29-9244	39-28-9248		

4.20mm (.165") Pitch Mini-Fit Jr.™ Header

5566 Vertical, Dual Row Without Pegs, without Drain Holes

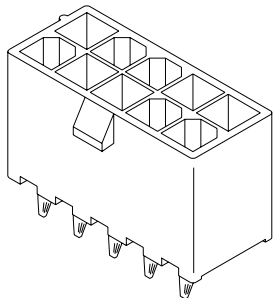

Features and Benefits

- Positive housing locks to mate with Mini-Fit Jr. receptacle
- Fully isolated terminals to protect contacts from damage
- Drain hole option available, contact Molex

Reference Information

Product Specification: PS-5556-001
 UL File No.: E29179
 CSA File No.: LR19980
 TUV License No.: R75142
 Mates With: 5557 dual row receptacle
 Use With: 5556 and 46083 terminals

Electrical

Current: 19.0A max. (See applicable product specification.)
 Voltage: 600V
 Contact Resistance: 10 milliohms max.

Mechanical

Mating Cycles: 30 cycles

Physical

Housing: 6/6 nylon, UL 94V-2 or 94V-0
 Contact Material: Brass

Circuits	Order No.		Plating	Tail Length	Lead-free
	94V-2	94V-0			
2	39-28-1023	39-28-8020	Tin	3.5mm	Yes
4	39-28-1043	39-28-8040			
6	39-28-1063	39-28-8060			
8	39-28-1083	39-28-8080			
10	39-28-1103	39-28-8100			
12	39-28-1123	39-28-8120			

Circuits	Order No.		Plating	Tail Length	Lead-free
	94V-2	94V-0			
14	39-28-1143	39-28-8140	Tin	3.5mm	Yes
16	39-28-1163	39-28-8160			
18	39-28-1183	39-28-8180			
20	39-28-1203	39-28-8200			
22	39-28-1223	39-28-8220			
24	39-28-1243	39-28-8240			

4.20mm (.165") Pitch Mini-Fit Jr.™ Header

5569 Right Angle, Dual Row with Pegs

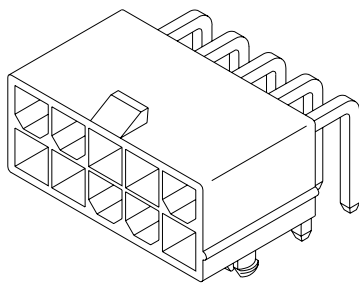

Features and Benefits

- Board mounting pegs provide polarization during placement on PCB and increased board retention during solder processing
- Low profile for space constraints
- Positive housing locks
- Fully isolated terminals to protect contacts from damage

Reference Information

Product Specification: PS-5556-001
 UL File No.: E29179
 CSA File No.: LR19980
 TUV License No.: R75142
 Mates With: 5557 dual row receptacles
 Use With: 5556, 46083 and 45750 terminals

Electrical

Current: 12.0A max. (See applicable product specification.)
 Voltage: 600V
 Contact Resistance: 10 milliohms max.

Mechanical

Mating Cycles: 30 cycles

Physical

Housing: 6/6 nylon, UL 94V-2 or 94V-0
 Contact Material: Brass

Circuits	Order No.				Tail Length	Lead-free
	Tin Plated		Select Gold Plated (30µL")			
	94V-2	94V-0	94V-2	94V-0		
2	39-30-7025	39-30-7026	39-30-0023	39-30-0024	3.6mm	Yes
4	39-30-7045	39-30-7046	39-30-0043	39-30-0044		
6	39-30-7065	39-30-7066	39-30-0063	39-30-0064		
8	39-30-7085	39-30-7086	39-30-0083	39-30-0084		
10	39-30-7105	39-30-7106	39-30-0103	39-30-0104		
12	39-30-7125	39-30-7126	39-30-0123	39-30-0124		
14	39-30-7145	39-30-7146	39-30-0143	39-30-0144		
16	39-30-7165	39-30-7166	39-30-0163	39-30-0164		
18	39-30-7185		39-30-0183			
20	39-30-7205	39-30-7206	39-30-0203	39-30-0204		
22	39-30-7225					
24	39-30-7245	39-30-7246	39-30-0243	39-30-0244		

4.20mm (.165") Pitch Mini-Fit Jr.™ Header

5569

Right Angle, Dual Row With Flanges

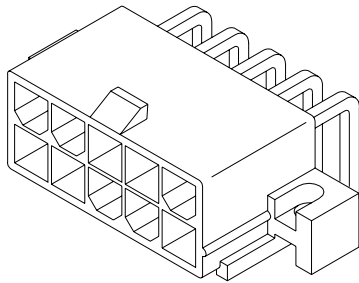

Features and Benefits

- Flanges allow for screw-in retention to board-mounted header
- Low profile for space constraints
- Positive housing locks

Reference Information

Product Specification: PS-5556-001
 UL File No.: E29179
 CSA File No.: LR19980
 TUV License No.: R75142
 Mates With: 5557 dual row receptacles
 Use With: 5556, 46083 and 45750 terminals

Electrical

Current: 12.0A max. (See applicable product specification.)
 Voltage: 600V
 Contact Resistance: 10 milliohms max.

Mechanical

Mating Cycles: 30 cycles

Physical

Housing: 6/6 nylon, UL 94V-2 or 94V-0
 Contact Material: Brass

Circuits	Order No.		Plating	Tail Length	Lead-free
	94V-2	94V-0			
2	39-29-1028	39-29-1027	Tin	3.5mm	Yes
4	39-29-1048	39-29-1047			
6	39-29-1068	39-29-1067			
8	39-29-1088	39-29-1087			
10	39-29-1108	39-29-1107			
12	39-29-1128	39-29-1127			

Circuits	Order No.		Plating	Tail Length	Lead-free
	94V-2	94V-0			
14	39-29-1148	39-29-1147	Tin	3.5mm	Yes
16	39-29-1168	39-29-1167			
18	39-29-1188	39-29-1187			
20	39-29-1208	39-29-1207			
22	39-29-1228	39-29-1227			
24	39-29-1248	39-29-1247			

4.20mm (.165") Pitch Mini-Fit Jr.™ Wire-to-Board Header

87427

Vertical without Flanges High Temperature Material

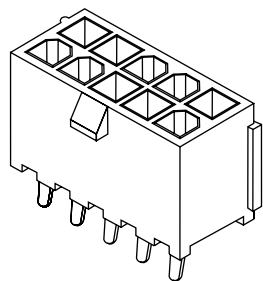

Features and Benefits

- Molded in high temperature, surface mount compatible material
- Fully isolated terminals to protect contacts from damage

Reference Information

Product Specification: PS-87427-0001
 UL File No.: E29179
 CSA File No.: LR19980
 Mates With: 5557 dual row receptacles
 Use With: 5556, 46083 and 45750 terminals

Electrical

Current: 12.0A max. (See applicable product specification.)
 Voltage: 600V
 Contact Resistance: 10 milliohms max.

Mechanical

Mating Cycles: 30 cycles

Physical

Housing: 4/6 Nylon, UL 94V-0
 Contact Material: Brass

Circuits	Order No.		Tail Length	Lead-free
	Tin Over Nickel Plating	Tin Over Copper Plating		
2	87427-0242	87427-0243	3.3mm	Yes
4	87427-0442	87427-0443		
6	87427-0642	87427-0643		
8	87427-0842	87427-0843		
10	87427-1042	87427-1043		
12	87427-1242	87427-1243		

Circuits	Order No.		Tail Length	Lead-free
	Tin Over Nickel Plating	Tin Over Copper Plating		
14	87427-1442	87427-1443	3.3mm	Yes
16	87427-1642	87427-1643		
18	87427-1842	87427-1843		
20	87427-2042	87427-2043		
22	87427-2242	87427-2243		
24	87427-2442	87427-2443		

4.20mm (.165") Pitch Mini-Fit Jr.™ Wire-to-Board Header

87427
Right Angle without Flanges
High Temperature Material

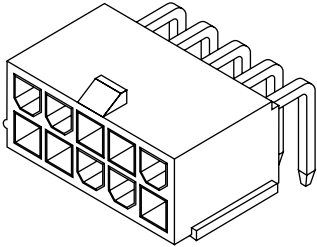

Features and Benefits

- Molded in high temperature, surface mount compatible material
- Fully isolated terminals to protect contacts from damage

Reference Information

Product Specification: PS-87427-0001
UL File No.: E29179
CSA File No.: LR19980
Mates With: 5557 dual row receptacle
Use With: 5556, 46083 and 45750 terminals

Electrical

Current: 12.0A max. (See applicable product specification.)
Voltage: 600V
Contact Resistance: 10 milliohms max.

Mechanical

Mating Cycles: 30 cycles

Physical

Housing: Nylon 4/6, UL 94V-0
Contact Material: Brass

Circuits	Order No.		Tail Length	Lead-free
	Tin Over Nickel Plating	Tin Over Copper Plating		
2	87427-0202	87427-0203	3.3mm	Yes
4	87427-0402	87427-0403		
6	87427-0602	87427-0603		
8	87427-0802	87427-0803		
10	87427-1002	87427-1003		
12	87427-1202	87427-1203		

Circuits	Order No.		Tail Length	Lead-free
	Tin Over Nickel Plating	Tin Over Copper Plating		
14	87427-1402	87427-1403	3.3mm	Yes
16	87427-1602	87427-1603		
18	87427-1802	87427-1803		
20	87427-2002	87427-2003		
22	87427-2202	87427-2203		
24	87427-2402	87427-2403		

4.20mm (.165") Pitch Mini-Fit Jr.™ Wire-to-Board Header

87427
Right Angle with Flange
High Temperature Material

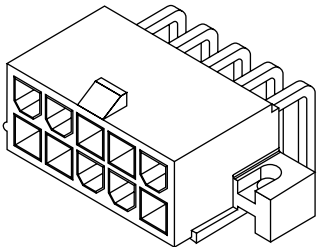

Features and Benefits

- Molded in high temperature, surface mount compatible material
- Fully isolated terminals to protect contacts from damage

Reference Information

Product Specification: PS-87427-0001
UL File No.: E29179
CSA File No.: LR19980
Mates With: 5557 dual row receptacle
Use With: 5556, 46083 and 45750 terminals

Electrical

Current: 12.0A max. (See applicable product specification.)
Voltage: 600V
Contact Resistance: 10 milliohms max.

Mechanical

Mating Cycles: 30 cycles

Physical

Housing: 4/6 Nylon, UL 94V-0
Contact Material: Brass

Circuits	Order No.		Tail Length	Lead-free
	Tin Over Nickel Plating	Tin Over Copper Plating		
2	87427-0212	87427-0213	3.3mm	Yes
4	87427-0412	87427-0413		
6	87427-0612	87427-0613		
8	87427-0812	87427-0813		
10	87427-1012	87427-1013		
12	87427-1212	87427-1213		

Circuits	Order No.		Tail Length	Lead-free
	Tin Over Nickel Plating	Tin Over Copper Plating		
14	87427-1412	87427-1413	3.3mm	Yes
16	87427-1612	87427-1613		
18	87427-1812	87427-1813		
20	87427-2012	87427-2013		
22	87427-2212	87427-2213		
24	87427-2412	87427-2413		

4.20mm (.165") Pitch Mini-Fit Plus HCS™ Connector System

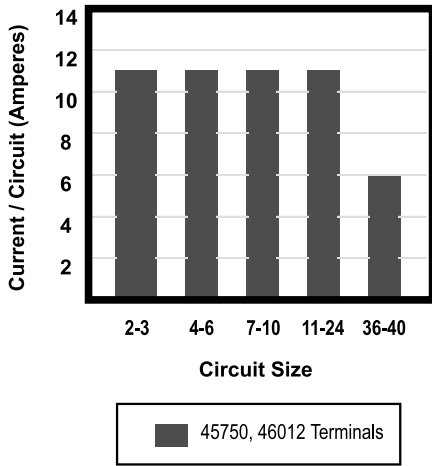

Features

- High Current**
 The base material of the terminals and stamped pins is a highly-conductive copper alloy. Heat generated at the contact interface is quickly dissipated. The system is suitable for applications that require high current loads.
- Hot Pluggable**
 The gold-plated terminals, PCB receptacle and headers are ideal for applications that require repeated "hot" mates and unmates.
- Flexible Design**
 Blind-mating, Positive Locking and Terminal Position Assurance solutions are available in the high current format.
- Configurations**
 Receptacle housings, PCB receptacles, plugs housings and headers in different combinations enable wire-to-wire, wire-to-board, panel-to-panel, panel-to-board or board-to-board designs.
- Polarized Geometry**
 The receptacle housings and PCB receptacles are polarized to the plug housings and headers to minimize the chance of mismatching the connectors.
- Lead-free**
 All Mini-Fit Plus HCS connectors have been lead-free since inception.

Specifications

Current Rating: 12.0A max. (16 AWG wire)
 Voltage Rating: 600V
 Contact Resistance:
 10 milliohms max. (initial)
 20 milliohms max. (after environmental testing)
 Wire Range:
 16 AWG (2.20 to 3.15mm insulation OD)
 18 to 20 AWG (1.65 to 2.95mm insulation OD)
 Plating Options: Tin, Select Gold
 Current Interruption (Hot Pluggability): 8.0A max.,
 24V max., 50 mating cycles max. (Gold-plated only)
 Applicable PCB Solder Processes:
 Wave Solder—42440, 42404, 42385, 43644, 43810,
 43973, 44068, 45567 and 46011
 Reflow—44068, 43810

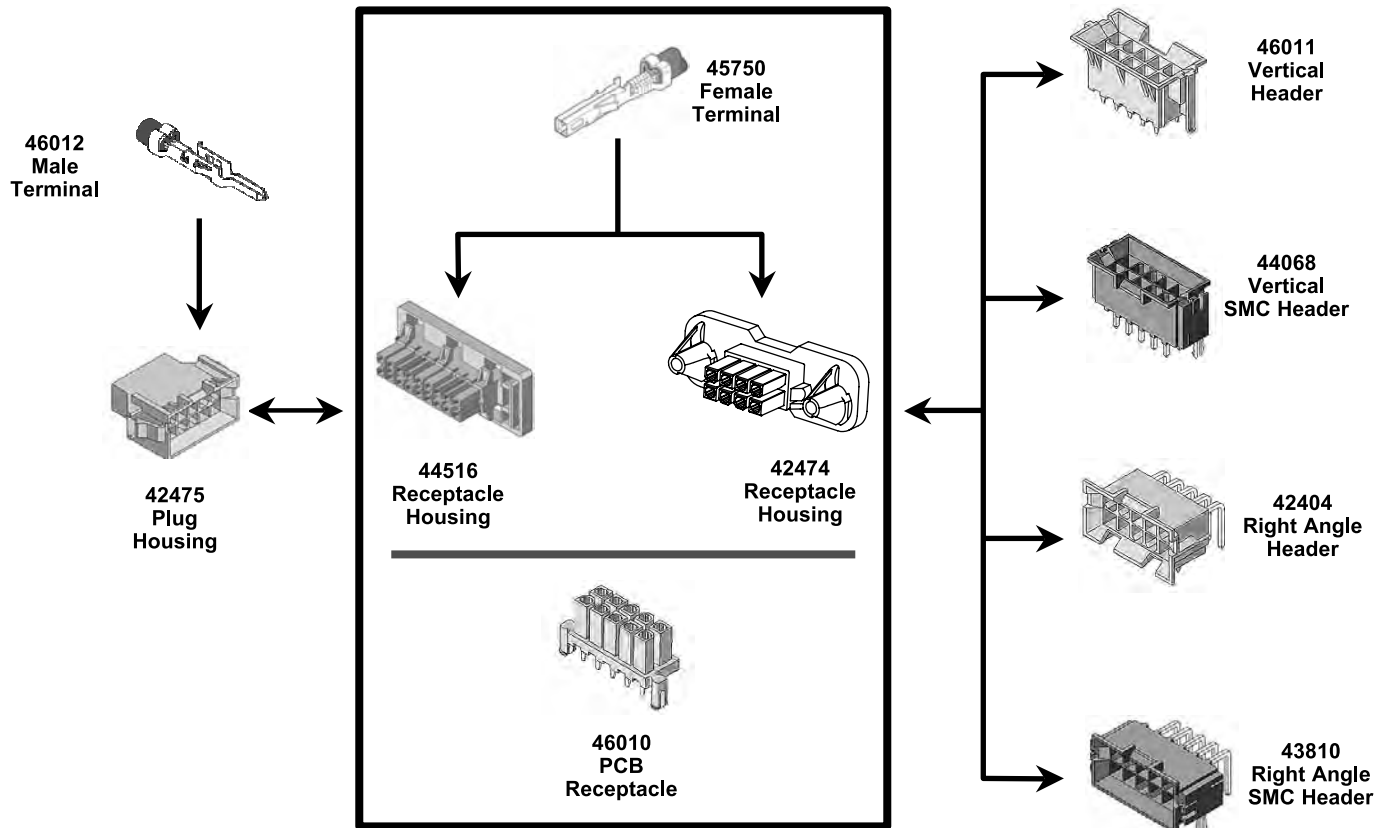

4.20mm (.165") Pitch Mini-Fit Plus HCS™ Connector System

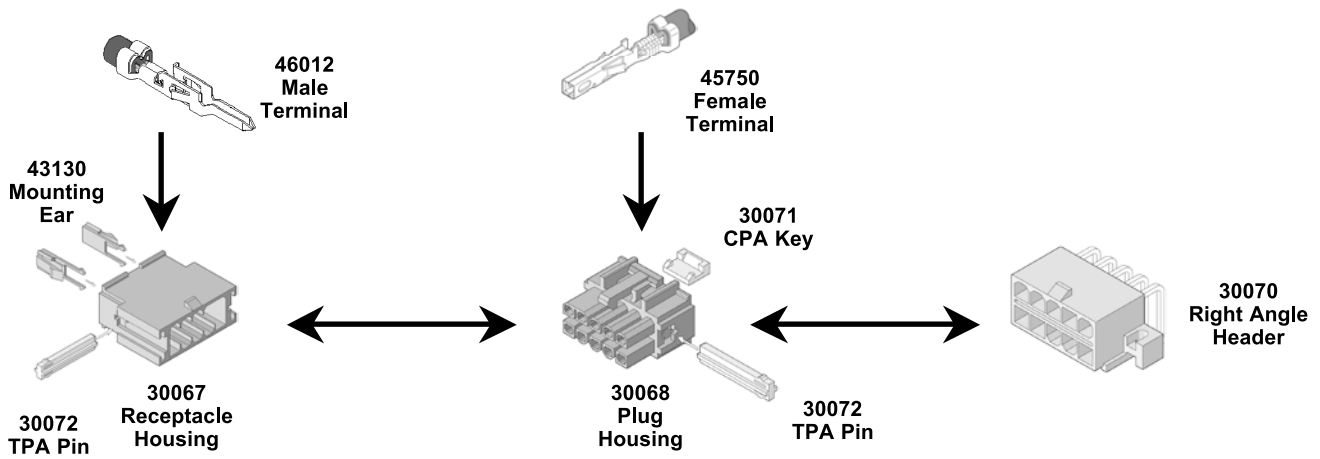
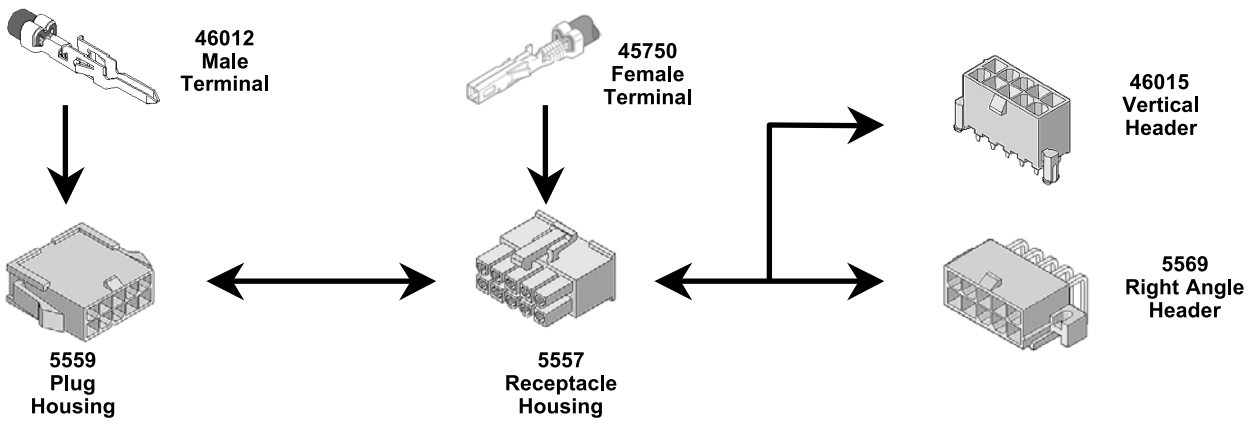
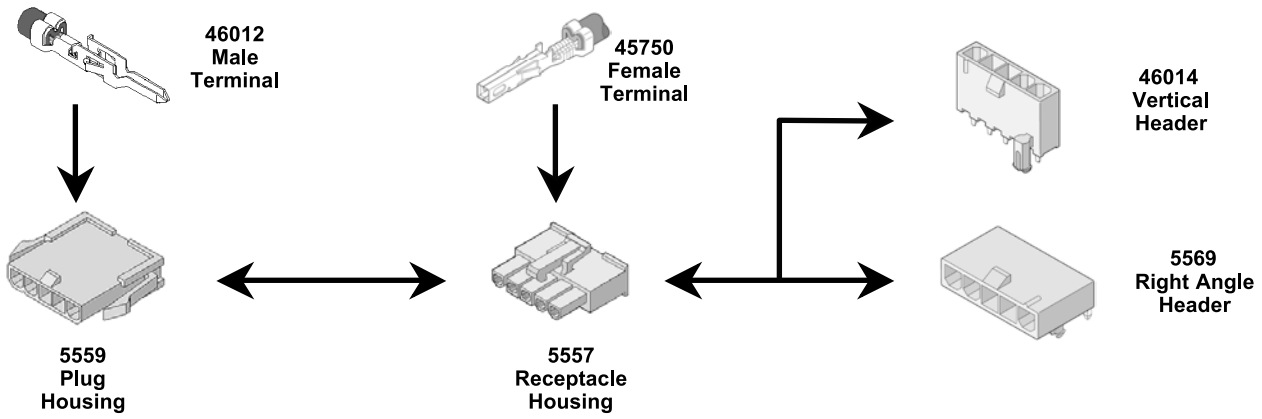

4.20mm (.165") Pitch Mini-Fit Plus HCS™ Crimp Terminal

45750
Female

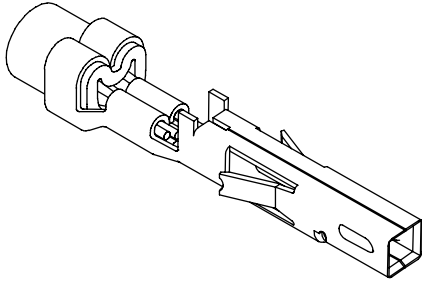

Features and Benefits

- Post-plated contacts for superior electrical performance over time
- Suitable for high current applications
- Locking tangs secure terminal to housing

Reference Information

Product Specification: PS-45250
Application Specification:
Mates With: 46012, 46104, 46015, 46011
Use With: 5557, 42474, 44516 and 30067 housings

Electrical

Voltage: 600V
Current: 12.0A max. (See applicable product specification.)
Contact Resistance: 10 milliohms max.

Mechanical

Mating Force: 14.7N max.
Unmating Force: 1.0N min.
Normal Force: 200g min.
Mating Cycles: Tin—30 cycles
Gold—100 cycles

Physical

Contact: Copper Alloy

Plating	Wire Range AWG	Reel	Bag	Lead-free
Tin	16	45750-3111	45750-3112	Yes
	18-20	45750-1111	45750-1112	
30µL Select Gold	16	45750-3211	45750-3212	
	18-20	45750-1211	45750-1212	

4.20mm (.165") Pitch Mini-Fit Plus HCS™ Crimp Terminal

46012
Male

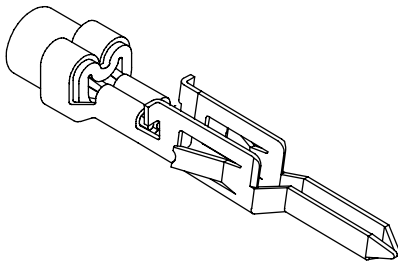

Features and Benefits

- Post-plated contacts for superior electrical performance over time
- Suitable for high current applications
- Locking tangs secure terminal to housing

Reference Information

Product Specification: PS-45750
Application Specification:
Mates With: 45750 and 46010
Use With: 5559, 42475 and 30068 housings

Electrical

Voltage: 600V
Current: 12.0A (See applicable product specification.)
Contact Resistance: 10 milliohms max.

Mechanical

Mating Force: 14.7N max.
Unmating Force: 1.0N max.
Mating Cycles: Tin—30 cycles
Gold—100 cycles

Physical

Contact: Copper Alloy
Plating: Tin or Select Gold
Wire Size: 16-20 AWG (See Product and Application Tooling specifications for complete crimping guidelines.)

Plating	Wire Range AWG	Reel	Bag	Lead-free
Tin	16	46012-3141	46012-3142	Yes
	18-20	46012-1141	46012-1142	
30µL Select Gold	16	46012-3241	46012-3242	
	18-20	46012-1241	46012-1242	

4.20mm (.165") Pitch Mini-Fit Plus HCS™ Header

46014 Single Row, Vertical With Pegs and Drain Holes

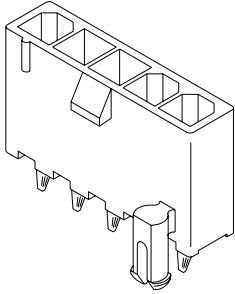

Features and Benefits

- Carries more amperes per circuit than 5566 series headers
- Headers standard with mounting pegs for increased board retention
- Single row configuration saves board space

Reference Information

Product Specification: PS-45750
Mates With: 5557 single row receptacle housing using 45750 terminal

Electrical

Voltage: 600V
Current: 12.0A max. (See applicable product specification.)
Contact Resistance: 10 milliohms max.

Mechanical

Mating Cycles: Tin—30 cycles
Gold—100 cycles

Physical

Housing: 6/6 nylon, UL 94V-0
Contact: High Copper Alloy
Plating: Tin or Select Gold

Circuits	Order No.		Tail Length	Lead-free
	Tin	30µm Select Gold		
3	46014-0300	46014-0302	3.5mm (.14")	Yes
4	46014-0400	46014-0402		
5	46014-0500	46014-0502		

4.20mm (.165") Pitch Mini-Fit Plus HCS™ Header

46015 Dual Row, Vertical With Pegs, Without Drain Holes

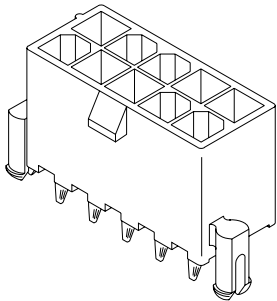

Features and Benefits

- Carries more amperes per circuit than 5566 series headers
- Headers standard with mounting pegs for increased board retention
- Positive housing locks

Reference Information

Product Specification: PS-45750
Mates With: 5557 housings using 45750 terminal

Electrical

Voltage: 600V
Current: 12.0A max. (See applicable product specification.)
Contact Resistance: 10 milliohms max.

Mechanical

Mating Cycles: Tin—30 cycles
Gold—100 cycles

Physical

Housing: 6/6 nylon, UL 94V-0
Contact: High Copper Alloy
Plating: Tin or Select Gold

Circuits	Order No.		Tail Length	Lead-free		
	Tin	30µm Select Gold				
2	46015-0201	46015-0208	3.5mm (.14")	Yes		
4	46015-0401	46015-0408				
6	46015-0601	46015-0608				
8	46015-0801	46015-0808				
10	46015-1001	46015-1008				
12	46015-1201	46015-1208				
14	46015-1401	46015-1408			3.5mm (.14")	Yes
16	46015-1601	46015-1608				
18	46015-1801	46015-1808				
20	46015-2001	46015-2008				
22	46015-2201	46015-2208				
24	46015-2401	46015-2408				

4.20mm (.165") Pitch Mini-Fit Plus HCS™ Header

46011
Dual Row, Vertical
With Pegs and Drain Holes

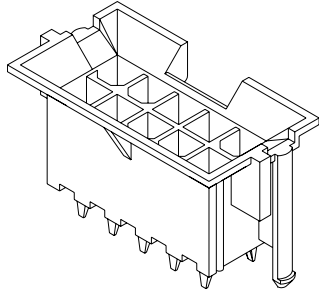

Features and Benefits

- Carries more amperes per circuit than 42440 series headers
- .100" lead-in for self-aligning connection with receptacle
- Polarizing pegs for increased board retention during wave soldering

Reference Information

Product Specification: PS-45750
Mates With: 42474, 44516 and 5557 receptacles and 46010 PCB receptacles
Use With: 44476 HCS terminals

Electrical

Voltage: 600V
Current: 12.0A max. (See applicable product specification.)
Contact Resistance: 10 milliohms max.

Mechanical

Mating Cycles: Tin—30 cycles
Gold—100 cycles

Physical

Housing: 6/6 nylon, UL 94V-0
Contact: High Copper Alloy
Plating: Tin or Select Gold

Circuits	Order No.		Tail Length	Lead-free
	Tin	30µ" Select Gold		
4	46011-0402	46011-0403	3.5mm (.14")	Yes
6	46011-0602	46011-0603		
10	46011-1002	46011-1003		
14	46011-1402	46011-1403		
18	46011-1802	46011-1803		
24	46011-2402	46011-2403		

4.20mm (.165") Pitch Mini-Fit Plus HCS™ PCB Receptacle

46010
Vertical
Dual Row

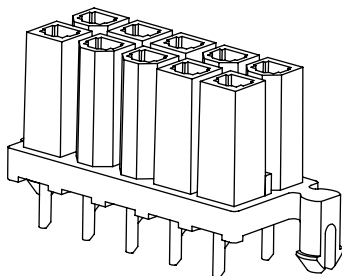

Features and Benefits

- Fully polarized housing prevents mismatching
- Board mounted receptacle for board-to-board applications
- Mateable with Mini-Fit BMI™ style housings and headers only
- The 46010 is not a floating connector. Guidance and float must be provided to align the connectors during mating and to provide stress-free positioning after mating.

Reference Information

Product Specification: PS-45750
Mates With: 42404 and 46011 headers, 42475 plug

Electrical

Voltage: 600V
Current: 12.0A max. (See applicable product specification.)
Contact Resistance: 10 milliohms max.

Mechanical

Mating Force: 14.7N max.
Unmating Force: 1.0N min.
Normal Force: 1.47 N min.
Mating Cycles: Tin—30 cycles
Gold—100 cycles

Physical

Housing: 6/6 nylon, UL 94V-0
Contact: Copper Alloy
Plating: Tin or Select Gold

Circuits	Order No.		Tail Length	Lead-free
	Tin	30µ" Select Gold		
4	46010-0421	46010-0422	3.5mm (.14")	Yes
6	46010-0621	46010-0622		
10	46010-1021	46010-1022		
14	46010-1421	46010-1422		
18	46010-1821	46010-1822		
24	46010-2421	46010-2422		

4.20mm (.165") Pitch Mini-Fit BMI™ Connector System

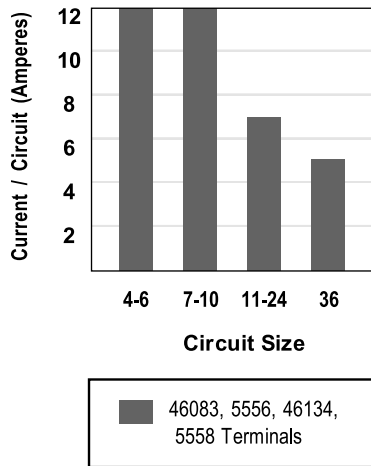

Features

- Blindmating**
 The panel-mount receptacle housings are designed so they can float a maximum of $\pm 1.27\text{mm}$ (.050") in the x and y-axis, once installed. The plug housings and the headers feature a wide lead-in bevel to gather and align the free-floating receptacle housings.
- Configurations**
 Receptacle housings, PCB receptacles, plugs housings, and headers in different combinations enable panel-to-panel, panel-to-board or board-to-board designs.
- Polarized Geometry**
 The receptacle housings and PCB receptacles are polarized to the plug housings and headers to minimize the chance of mismatching the connectors.
- Surface Mount Compatible Headers**
 Vertical and right angle headers for reflow solder processing are available.
- Compliant Pin Headers**
 Vertical headers are available for flat rock/press fit processing
- Lead-free**
 Unless otherwise noted, the Mini-Fit BMI connectors are lead-free.
- MFBL**
 Molex offers mate first, break last header options

Specifications

Current Rating: 9.0A max. (16 AWG wire)
 Voltage Rating : 600V
 Contact Resistance:
 10 milliohms max. (initial),
 20 milliohms max. (after environmental testing)
 Wire Range:
 16 AWG (2.20 to 3.15mm insulation OD)
 18 to 20 AWG (1.65 to 2.95mm insulation OD)
 22 to 24 AWG (1.20 to 1.80mm insulation OD)
 PCB Thickness:
 1.60mm (0.062")—42440, 42404, 42385, 45567, 43973, 44068 and 43810
 2.40mm (.094")—43644, 44068, 43810, 43879
 3.20mm (0.125")—44068, 43810, 43879
 6.40mm (0.250")—44068, 43810, 43879
 Applicable PCB Solder Processes:
 Wave Solder—42440, 42404, 42385, 45567, 43973, 43644, 44068 and 43810
 Reflow—44068, 43810
 Press Fit—43879
 Agency Approvals: UL, CSA, TUV

E

Power Connectors

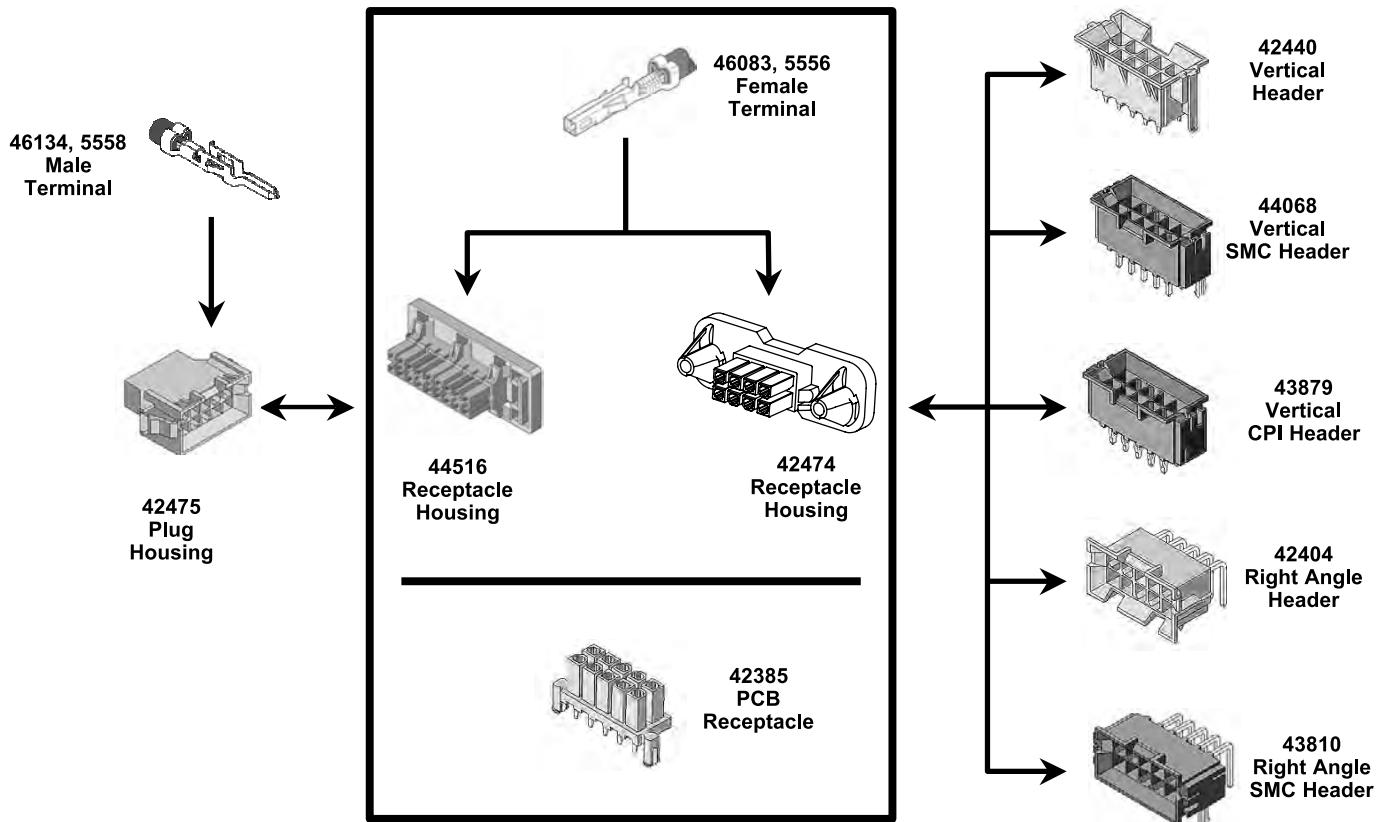

4.20mm (.165") Pitch Mini-Fit BMI Slide-and-Lock™ Crimp Terminal Housing Receptacle

44516
Dual Row, Panel Mount

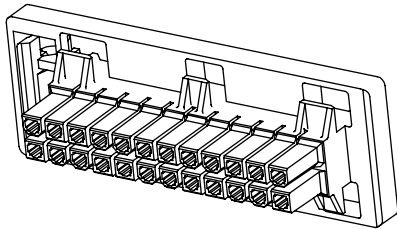

Circuits	Order No.	Lead-Free	
4	Contact Molex	Yes	
6			
10			
14			
18			44516-0009
24			44516-0012
36	44516-0013		

Features and Benefits

- Blindmating panel mount connector
- Designed for wire-to-board or wire-to-wire applications
- Fully isolated silos to protect contacts from damage
- Slide-and-Lock feature allows receptacles to be installed and removed many times

Reference Information

Product Specification: PS-44516-001
 UL File No.: E29197
 CSA File No.: LR19980
 Mates With: 42440, 42404, 43759, 46011, 44068, 43810, 43879, 46099 or 46100 headers and 42475 or 43770 plug housings
 Use With: 46083, 5556, 45750 or 46018 terminals
 Panel Thickness: 1.19 to 1.57mm (.047 to .062")

Physical

Housing: PBT polyester, UL 94V-0

4.20mm (.165") Pitch Mini-Fit BMI™ Crimp Terminal Housing Receptacle

42474
Dual Row
With Panel Mount Ears

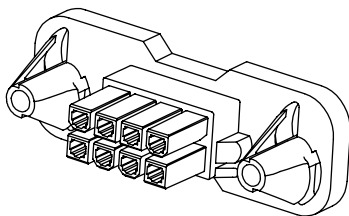

Circuits	Order No.	
	94V-2	94V-0
4	15-06-0040	15-06-0041
6	15-06-0060	15-06-0061
8	15-06-0080	
10	15-06-0100	15-06-0101
14	15-06-0140	15-06-0141
18	15-06-0180	15-06-0181
24	15-06-0240	15-06-0241

Features and Benefits

- Blind mating panel mount receptacle
- For wire-to-wire and wire-to-board applications
- Fully isolated terminals to protect contacts from damage

Reference Information

Product Specification: PS-5556-002
 UL File No.: E29179
 CSA File No.: LR19980
 TUV License No.: R75142-8
 Mates With: 42404, 42440, 43810, 43879, 44068, 46011, 46099 and 46100 headers or 42475 plug
 Use With: 5556, 46083, 45750 or 46018 terminals
 Panel Thickness: 0.97 to 1.57mm (.038 to .062")

Physical

Housing: 6/6 nylon, UL 94V-2 or 94V-0

4.20mm (.165") Pitch Mini-Fit BMI™ Crimp Terminal Housing Plug

42475
Dual Row
With Panel Mount Ears

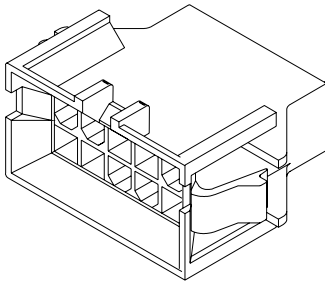

Features and Benefits

- Blind mating panel mounted plug
- Positive housing locks to mate with Mini-Fit Jr.
- Fully isolated terminals to protect contacts from damage

Reference Information

Product Specification: PS-5556-002
UL File No.: E29179
CSA File No.: LR19980
TUV License No.: R75142
Mates With: 5557, 42474 or 44516 receptacles and 42385, 46010 or 46101 PCB receptacles
Use With: 5558, 46134, 46012 or 46098 terminals
Panel Thickness: 1.60mm (.063") max.

Physical

Housing: 6/6 nylon, UL 94V-2 or 94V-0

Circuits	Order No.	
	94V-2	94V-0
4	15-06-0045	15-06-0046
6	15-06-0065	15-06-0066
8	15-06-0085	
10	15-06-0105	15-06-0106
14	15-06-0145	15-06-0146
18	15-06-0185	15-06-0186
24	15-06-0245	15-06-0246

4.20mm (.165") Pitch Mini-Fit BMI™ Header

42440
Dual Row, Vertical, with Pegs

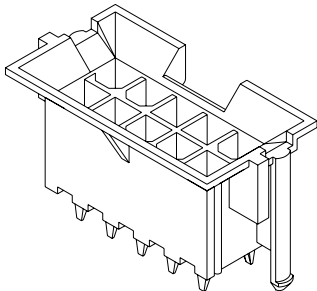

Features and Benefits

- .100" lead-in for self aligning connection with receptacle
- Standard with drain holes to allow PCB washing after wave soldering (contact Molex for headers without drain holes)
- Fully isolated terminals to protect contacts from damage

Reference Information

Product Specification: PS-5556-002
UL File No.: E29179
CSA File No.: LR19980
Mates With: 44516, 42474 and 5557 dual row receptacles or 42385 PCB receptacles

Electrical

Voltage: 600V
Current: 9.0A max. (See applicable product specification.)
Contact Resistance: 10 milliohms max.

Mechanical

Mating Cycle: 30 cycles

Physical

Housing: 6/6 nylon, UL 94V-2 or 94V-0
Contact: Brass
Plating: Tin or Select Gold

Circuits	Order No.				Tail Length	Lead-free
	Tin		30µL Select Gold			
	94V-2	94V-0	94V-2	94V-0		
4	15-24-6046	15-24-6047	15-28-6046	15-28-6047	3.5mm (.14")	Yes
6	15-24-6066		15-28-6066			
10	15-24-6106	15-24-6107	15-28-6106	15-28-6107		
14	15-24-6146	15-24-6147	15-28-6146	15-28-6147		
18	15-24-6186	15-24-6187	15-28-6186	15-28-6187		
24	15-24-6246	15-24-6247	15-28-6246	15-28-6247		

4.20mm (.165") Pitch Mini-Fit BMI™ Surface Mount Compatible Header

44068
Vertical, Dual Row

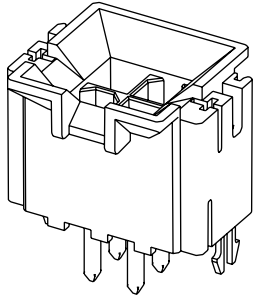

Features and Benefits

- Surface Mount Compatible (245°C)
- Fully isolated terminals to protect contacts from damage
- Designs for variety of board thicknesses
- Metal retention clip holds product before and after the soldering process
- Blind-mating capabilities
- Available without clips

Reference Information

Product Specification: PS-43810-001
Mates With: 42474, 44516 and 5557 dual row receptacles and 42385 or 46010 PCB receptacle headers

Electrical

Voltage: 600V
Current: 12.0A max. (See applicable product specification.)
Contact Resistance: 10 milliohms max.

Mechanical

Mating Cycles: 30 cycles

Physical

Housing: 4/6 nylon, UL 94V-0
Contact: Brass
Plating: Tin or Select Gold

Circuits	Plating	Order No.			Lead-Free
		Tail Length 3.30mm (.130")	Tail Length 4.42mm (.174")	Tail Length 4.88mm (.192")	
4	Tin	44068-0001	44068-0045	44068-0089	Yes
	30µ" Select Gold	44068-0012	44068-0056	44068-0100	
6	Tin	44068-0002	44068-0046	44068-0090	
	30µ" Select Gold	44068-0013	44068-0057	44068-0101	
10	Tin	44068-0004	44068-0048	44068-0092	
	30µ" Select Gold	44068-0015	44068-0059	44068-0103	
14	Tin	44068-0006	44068-0050	44068-0094	
	30µ" Select Gold	44068-0017	44068-0061	44068-0105	
18	Tin	44068-0008	44068-0052	44068-0096	
	30µ" Select Gold	44068-0019	44068-0063	44068-0107	
24	Tin	44068-0011	44068-0055	44068-0099	
	30µ" Select Gold	44068-0022	44068-0066	44068-0110	

4.20mm (.165") Pitch Mini-Fit BMI™ Compliant Pin Header

43879
Vertical, Dual Row

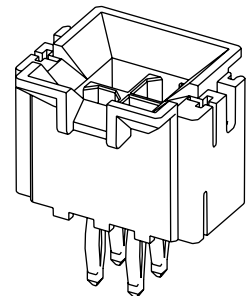

Features and Benefits

- Press-fit pin requiring no soldering
- Blindmating capabilities
- Designed for multiple board thicknesses

Reference Information

Product Specification: PS-43879-001
Mates With: 5557, 42385 and 42474 receptacles
PCB Thickness: .088" min.
Process: Press fit

Electrical

Voltage: 600V
Current: 7.0A max. (See applicable product specification.)
Contact Resistance: 10 milliohms max.

Mechanical

Insertion Force to PCB: 20kg max.
Mating Cycles: 30 cycles

Physical

Housing: 4/6 nylon, UL 94V-0
Contact: Phosphor Bronze
Plating: Tin or Select Gold

Circuits	Order No.		Lead-free
	Tin	30µ" Select Gold	
4	43879-0022	43879-0055	Yes
6	43879-0023	43879-0056	
10	43879-0025	43879-0058	
14	43879-0027	43879-0060	
18	43879-0029	43879-0062	
24	43879-0032	43879-0065	

Circuits	Order No.		Lead-free
	Tin	30µ" Select Gold	
4	43879-0044	43879-0033	No
6	43879-0045	43879-0034	
10	43879-0047	43879-0036	
14	43879-0049	43879-0038	
18	43879-0051	43879-0040	
24	43879-0054	43879-0043	

4.20mm (.165") Pitch Mini-Fit BMI™ Header

42404
Right Angle
Dual Row

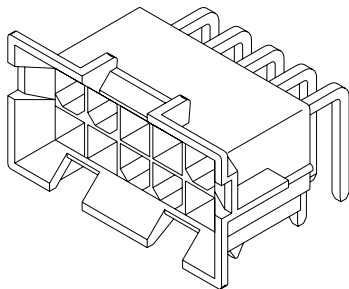

Features and Benefits

- Blindmating capabilities
- Fully isolated terminals to protect contacts from damage

Reference Information

Product Specification: PS-5556-002
UL File No.: E29179
CSA File No.: LR19980
Mates With: 42474, 44516 and 5557 dual row housings or 42385 and 46010 PCB receptacle headers

Electrical

Voltage: 600V
Current: 12.0A max. (See applicable product specification.)
Contact Resistance: 10 milliohms max.

Mechanical

Mating Cycles: 30 cycles

Physical

Housing: 6/6 nylon, UL 94V-2 or UL 94V-0
Contact: Brass
Plating: Tin or Select Gold

Circuits	Order No.				Tail Length	Lead-free
	Tin		30µm Select Gold			
	94V-2	94V-0	94V-2	94V-0		
4	15-24-6040	15-24-9044	15-24-9047	15-24-6043	3.3mm (.13")	Yes
6	15-24-6060	15-24-9064	15-24-9067	15-24-6063		
10	15-24-6100	15-24-9104	15-24-9107	15-24-6103		
14	15-24-6140	15-24-9144	15-24-9147	15-24-6143		
16		15-24-9164				
18	15-24-6180	15-24-9184	15-24-9187	15-24-6183		
24	15-24-6240	15-24-9244	15-24-9247	15-24-6243		

4.20mm (.165") Pitch Mini-Fit BMI™ Surface Mount Compatible Header

43810
Right Angle, Dual Row

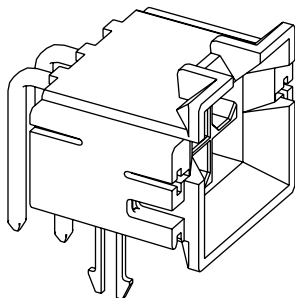

Features and Benefits

- Surface Mount Compatible (245°C)
- Fully isolated terminals to protect contacts from damage
- Metal retention clip holds product before and after the soldering process
- Blind-mating capabilities
- Designs for variety of board thicknesses available
- Available without clips

Reference Information

Packaging: Tray
UL File No.: E29179
CSA File No.: LR19980
TUV License No.: R75142
Mates With: 42474, 44516 and 5557 receptacles and 42385 or 46010 PCB receptacles

Electrical

Voltage: 600V
Current: 12.0A max. (See applicable product specification.)
Contact Resistance: 10 milliohms max.

Mechanical

Mating Cycles: 30 cycles

Physical

Housing: 4/6 nylon, UL 94V-0
Contact: Brass
Plating: Tin or Select Gold

Circuits	Plating	Order No.	Tail Length	Lead-free
		1.60mm (.063") PCB Thickness		
4	Tin	43810-0001	3.12mm (.123")	Yes
	30µm Select Gold	43810-0012		
6	Tin	43810-0002		
	30µm Select Gold	43810-0013		
10	Tin	43810-0004		
	30µm Select Gold	43810-0015		
14	Tin	43810-0006		
	30µm Select Gold	43810-0017		
18	Tin	43810-0008		
	30µm Select Gold	43810-0019		
24	Tin	43810-0011		
	30µm Select Gold	43810-0022		

4.20mm (.165") Pitch Mini-Fit BMI™ PCB Receptacle

42385
Vertical
Dual Row

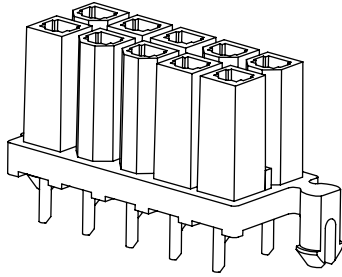

Features and Benefits

- Board-mounted receptacle for board-to-board applications
- Fully isolated terminals to protect contacts from damage
- The 42385 series is not inherently blindmating. Guidance to align the connectors during mating and float to provide stress-free positioning after mating must be provided

Reference Information

Product Specification: PS-5556-002
UL File No.: E29179
CSA File No.: LR19980
Mates With: 42475 plug, 42404, 42440, 43810, 43879 and 44068 headers

Electrical

Voltage: 600V
Current: 9.0A max. (See applicable product specification.)
Contact Resistance: 10 milliohms max.

Mechanical

Mating Force: 14.7N max.
Unmating Force: 1.0N max.
Normal Force: 1.47N min.
Mating Cycles: 30 cycles

Physical

Housing: 6/6 nylon, UL 94V-2 or 94V-0
Contact: Brass
Plating: Tin or Select Gold

Circuits	Order No.				Tail Length	Lead-free
	Tin		30µ" Select Gold			
	94V-2	94V-0	94V-2	94V-0		
4	15-24-7040	15-24-7041	15-24-7042	15-24-7043	3.5mm (.14")	Yes
6	15-24-7060	15-24-7061	15-24-7062	15-24-7063		
10	15-24-7100	15-24-7101	15-24-7102	15-24-7103		
14	15-24-7140	15-24-7141	15-24-7142	15-24-7143		
16	15-24-7160	15-24-7161	15-24-7162	15-24-7163		
18	15-24-7180	15-24-7181	15-24-7182	15-24-7183		
24	15-24-7240	15-24-7241	15-24-7242	15-24-7243		

4.20mm (.165") Pitch Mini-Fit BMI™ Header

45567
Right Angle
Dual Row

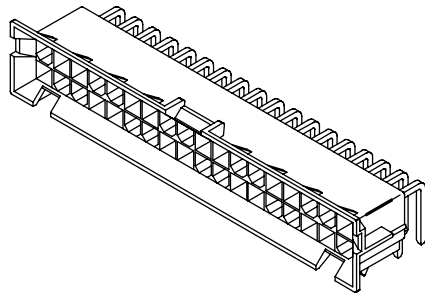

Features and Benefits

- Blindmating capabilities
- Top row of pins in header are longer and engage first when mated to reduce overall insertion force
- Fully isolated terminals to protect contacts from damage

Reference Information

Mates With: 44516 housing

Electrical

Voltage: 600V
Current: 6.0A

Mechanical

Mating Cycles: 30 cycles

Physical

Housing: Black polyester, UL 94V-0
Contact: Brass
Plating: Tin or Select Gold

Circuits	Order No.		Tail Length	Lead-free
	Tin	30µ" Select Gold		
36	45567-0001	45567-0002	3.3mm (.13")	Yes

4.20mm (.165") Pitch Mini-Fit BMI™ Crimp Terminal Housing Receptacle

43974

**Dual Row
With Panel Mount Ears**

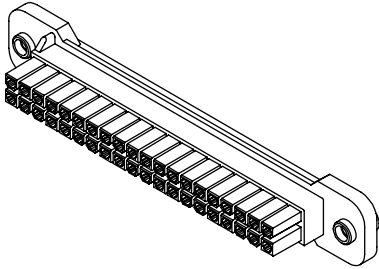

Circuits	Order No.	Lead-Free
40	43974-0005	Yes

Features and Benefits

- Blind mating panel mount receptacle
- For wire-to-board applications
- Fully isolated terminals to protect contacts from damage

Reference Information

UL File No.: E29179
 CSA File No.: LR19980
 TUV License: R75142
 Mates With: 43973 headers
 Use With: 45750, 46083, 46108 and 5556 terminals
 Accepts self tapping screws

Physical

Housing: Black 4/6 nylon, UL 94V-0

4.20mm (.165") Pitch Mini-Fit BMI™ Header

43973

**Right Angle
Dual Row**

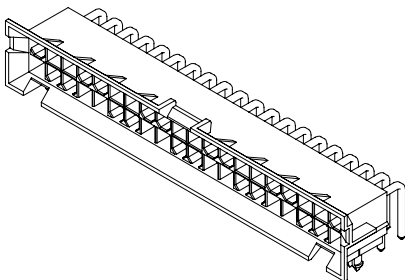

Features and Benefits

- Blindmating capabilities
- Top row of pins in header are longer and engage first when mated to reduce overall insertion force
- Fully isolated terminals to protect contacts from damage

Reference Information

Product Specification: PS-43759-0001
 UL File No.: E29179
 CSA File No.: LR19980
 TUV License: R75142
 Mates With: 43974 receptacle housing

Electrical

Voltage: 600V
 Current: 6.0A max.
 Contact Resistance: 10 milliohms max.

Mechanical

Mating Cycles: 30 cycles

Physical

Housing: Black 4/6 nylon, UL 94V-0
 Contact: Brass Alloy
 Plating: Tin or Select Gold

Circuits	Order No.		Tail Length	Lead-free
	Tin	30µ" Select Gold		
40	43973-0001	Contact Molex	3.30mm (.130")	Yes

4.20mm (.165") Pitch Mini-Fit Plus HMC™ Connector System

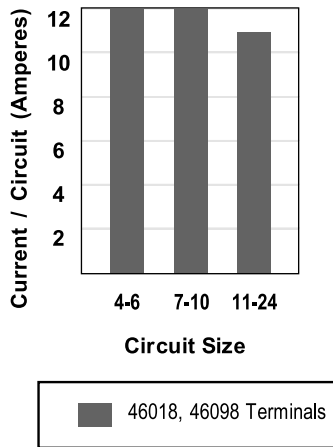

Features

- Enhanced Durability**
 The large elliptical contact configuration and Palladium Nickel plating allow these connectors to be mated hundreds of times while maintaining low contact resistance.
- Blindmating**
 The panel-mount receptacle housings are designed to float $\pm 1.27\text{mm}$ (.050") in the x and y-axes, once installed. The plug housings and the headers feature a wide lead-in bevel to gather and align the free-floating receptacle housings.
- Configurations**
 Receptacle housings, PCB receptacles, plugs housings and headers in different combinations enable panel-to-panel, panel-to-board or board-to-board designs.
- Polarized Geometry**
 The receptacle housings and PCB receptacles are polarized to the plug housings and headers to minimize the chance of mismatching the connectors.
- Lead-free**
 All Mini-Fit Plus HMC connectors have been lead-free since inception.

Specifications

Current Rating: 12.0A max. (16 AWG wire)
 Voltage Rating: 600V
 Contact Resistance:
 10 milliohms max. (initial)
 Wire Range:
 16 AWG
 18 to 20 AWG
 22 to 24 AWG
 Plating: Gold flash over Palladium Nickel
 Durability: 1,000 cycles

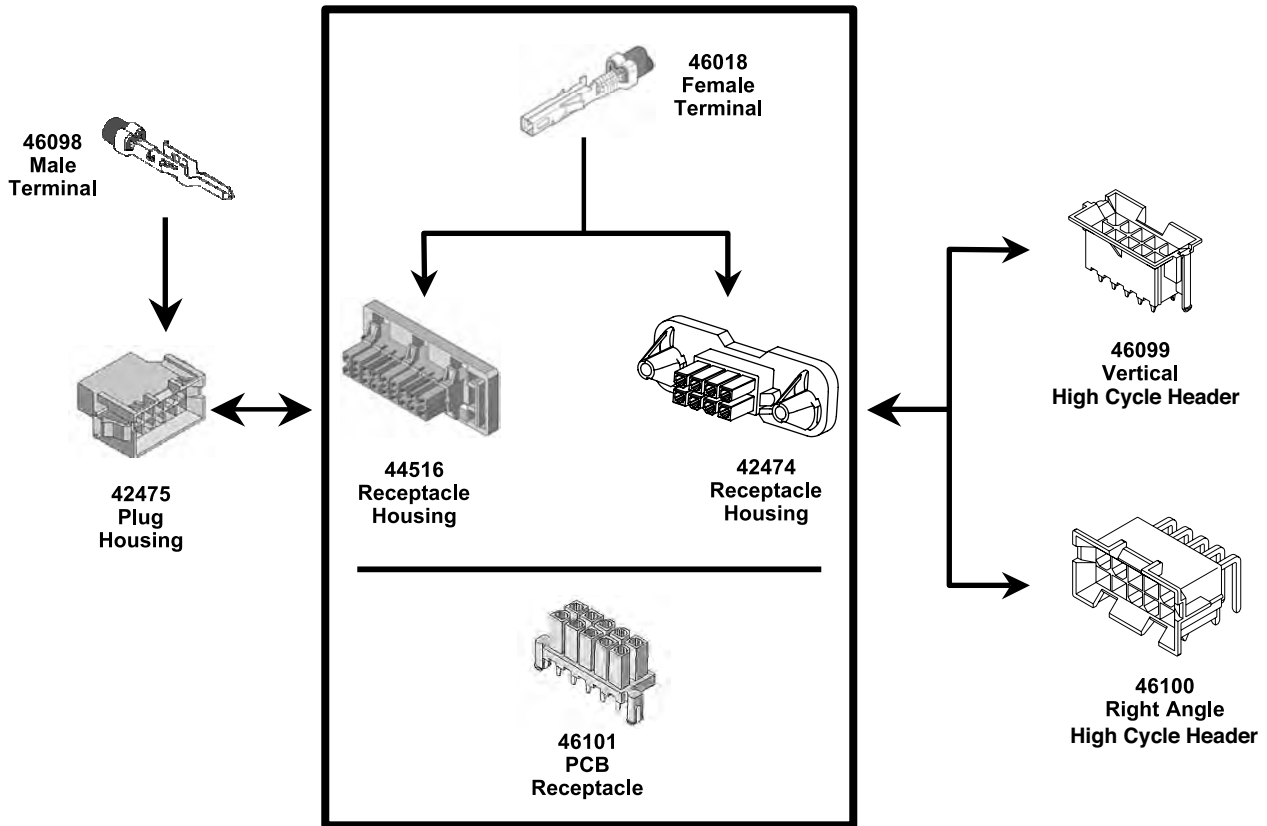

4.20mm (.165") Pitch Mini-Fit Plus HMC™ Terminal

46018
Crimp, Female

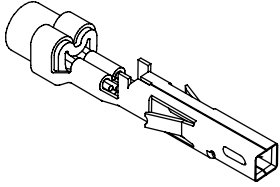

Features and Benefits

- Post-plated contacts for superior electrical performance over time
- High cycle terminal for power/signal applications
- Ideal for rack-mounted or drawer connecting modules requiring multiple insertions

Reference Information

Product Specification: PS-46018
UL File No: E29179
CSA File No: LR19980
TUV License No: R75142
Use with: 42474 and 44516 receptacles

Electrical

Current: 12.0A max. (See applicable product specification.)
Voltage: 600V
Contact Resistance: 10 milliohms max.

Mechanical

Mating Force: 14.7N max. per contact
Unmating Force: 1.0N min. per contact
Normal Force: 0.49N min. per contact
Mating Cycles: 1,000 cycles

Physical

Contact Material: Copper Alloy
Wire Size: 16-24 AWG (See Product and Application Tooling specifications for complete crimping guidelines.)

Wire Size (AWG)	Plating	Order Number		Lead-free
		Reel	Bag	
16	Gold flash over Palladium Nickel	46018-3541	46018-3542	Yes
18-20		46018-1541	46018-1542	
22-24		46018-2541	46018-2542	

4.20mm (.165") Pitch Mini-Fit Plus HMC™ Terminal

46098
Crimp, Male

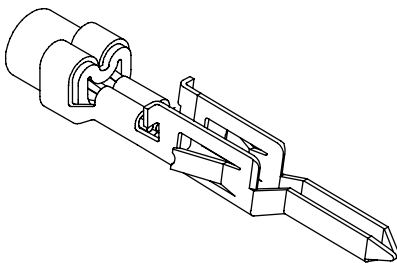

Features and Benefits

- Post-plated contacts for superior electrical performance over time
- High cycle terminal for power/signal applications
- Ideal for rack-mounted or drawer connecting modules requiring multiple insertions

Reference Information

Product Specification: PS-46018
UL File No: E29179
Use With: 42475 plug housing

Electrical

Current: 12.0A max. (See applicable product specification.)
Voltage: 600V
Contact Resistance: 10 milliohms max.

Mechanical

Mating Force: 14.7N max. per contact
Unmating Force: 1.0N max. per contact
Normal Force: 0.49N min. per contact
Mating Cycles: 1,000 cycles

Physical

Contact Material: Copper Alloy
Wire Size: 16-24 AWG (See Product and Application Tooling specifications for complete crimping guidelines.)

Wire Range AWG	Plating	Order Number		Lead-free
		Reel	Bag	
16	Gold Flash over Palladium Nickel	46098-3541	46098-3542	Yes
18-20		46098-1541	46098-1542	
22-24		46098-2541	46098-2542	

4.20mm (.165") Pitch Mini-Fit Plus HMC™ Header

46099
Vertical
Dual Row

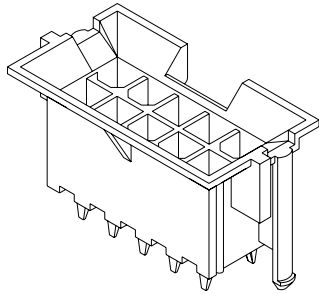

Features and Benefits

- Fully isolated terminals to protect contacts from damage
- Blind-mating header

Reference Information

Product Specification: PS-46018
UL File No: E29179
Mates With: 46101 PCB receptacles and 42474 or 44516 receptacles
Use With: 46018 High-cycle terminals

Electrical

Current: 12.0A max. (16 AWG min.)
(See applicable product specification.)
Voltage: 600V
Contact Resistance: 10 milliohms max.

Mechanical

Mating Cycles: 1,000 cycles

Physical

Housing: 6/6 nylon, UL 94V-0
Contact Material: Copper Alloy

Circuits	Order No.	Tail Length	Plating	Lead-Free
4	46099-0411	3.5mm	Gold Flash over Palladium Nickel	Yes
6	46099-0611			
10	46099-1011			
14	46099-1411			
18	46099-1811			
24	46099-2411			

4.20mm (.165") Pitch Mini-Fit Plus HMC™ Header

46100
Right Angle
Dual Row

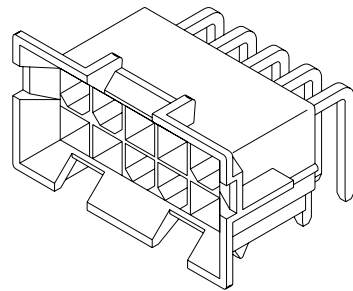

Features and Benefits

- Fully isolated terminals to protect contacts from damage
- Blind-mating header

Reference Information

Product Specification: PS-46018
UL File No: E29179
Mates With: 46101 PCB receptacles and 42474 or 44516 receptacles
Use With: 46018 High-cycle terminals

Electrical

Current: 12.0A max. (16 AWG wire) (See applicable product specification.)
Voltage: 600V
Contact Resistance: 10 milliohms max.

Mechanical

Mating Cycles: 1,000 cycles

Physical

Housing: 6/6 nylon, UL 94V-0
Contact Material: Copper Alloy

Circuits	Order No.	Tail Length	Plating	Lead-Free
4	46100-0411	3.3mm	Gold Flash over Palladium Nickel	Yes
6	46100-0611			
10	46100-1011			
14	46100-1411			
18	46100-1811			
24	46100-2411			

4.20mm (.165") Pitch Mini-Fit Plus HMC™ PCB Receptacle

46101
Vertical
Dual Row

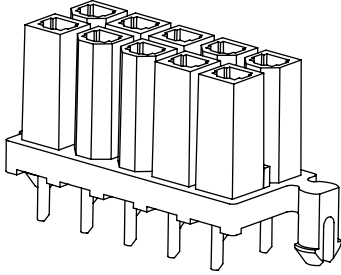

Features and Benefits

- Post-plated contacts for superior electrical performance over time
- Board-mounted receptacle header for board-to-board applications
- Fully isolated terminals to protect contacts from damage
- The 46101 is not a floating connector. Guidance and float must be provided to align the connectors during mating and to provide stress-free positioning after mating.

Reference Information

Product Specification: PS-46018
UL File No: E29179
Mates With: 42475 plug or 46100 and 46099 header
Use With: 46098 High-cycle terminals

Electrical

Current: 12.0A max. (See applicable product specification.)
Voltage: 600V
Contact Resistance: 10 milliohms max.

Mechanical

Mating Force: 14.7N max. per contact
Unmating Force: 1.0N min. per contact
Normal Force: 1.96 N min. per contact
Mating Cycles: 1,000 cycles

Physical

Housing: 6/6 nylon, UL 94V-0
Contact material: Copper Alloy

Circuits	Order No.	Tail Length	Plating	Lead-free
4	46101-0411	3.5mm (.14")	Gold Flash over Palladium Nickel	Yes
6	46101-0611			
10	46101-1011			
14	46101-1411			
18	46101-1811			
24	46101-2411			

4.20mm (.165") Pitch Mini-Fit TPA™ Connector System

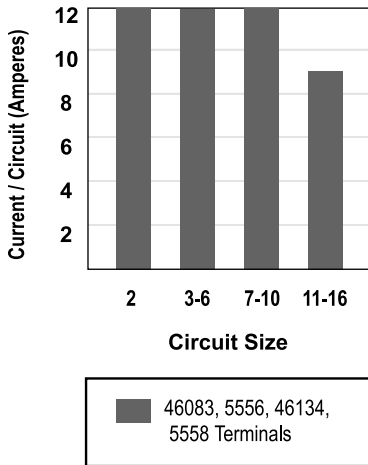

Features

- Terminal Position Assurance (TPA)**
 Terminal Position Assurance Pins are inserted into the receptacle or plug housings and will only fully seat if all the terminals have been fully engaged. The terminals are then held in place and can not back out.
- Positive Locking**
 Each receptacle housing is equipped with a locking thumb latch. Each plug housing or header features a locking ramp. When mated, the latch and ramp prevent the connectors from accidental unmating.
- Configurations**
 The receptacle housings, plug housings, and headers allow designs for wire-to-wire or wire-to-board applications.
- Polarized Mating Geometry**
 The receptacle housings and PCB receptacles are polarized relative to the plug housings and headers to minimize the chance of mismatching the connectors.
- Lead-free**
 The Mini-Fit TPA connectors are lead-free.

Specifications

Current Rating: 9.0A max. (16 AWG wire)
 Voltage Rating: 600V
 Contact Resistance:
 10 milliohms max. (initial),
 20 milliohms max. (after environmental testing)
 Wire Range:
 16 AWG (2.20 to 3.15mm insulation OD)
 18 to 20 AWG (1.65 to 2.95mm insulation OD)
 22 to 24 AWG (1.20 to 1.80mm insulation OD)
 Plating Options: Tin or Select Gold
 Housing Material: Polyester, UL 94V-0
 PCB Thickness: 1.6mm (0.62")—30069, 30070
 Applicable PCB Solder Process: Wave solder only
 Agency Approvals: UL, CSA, TUV

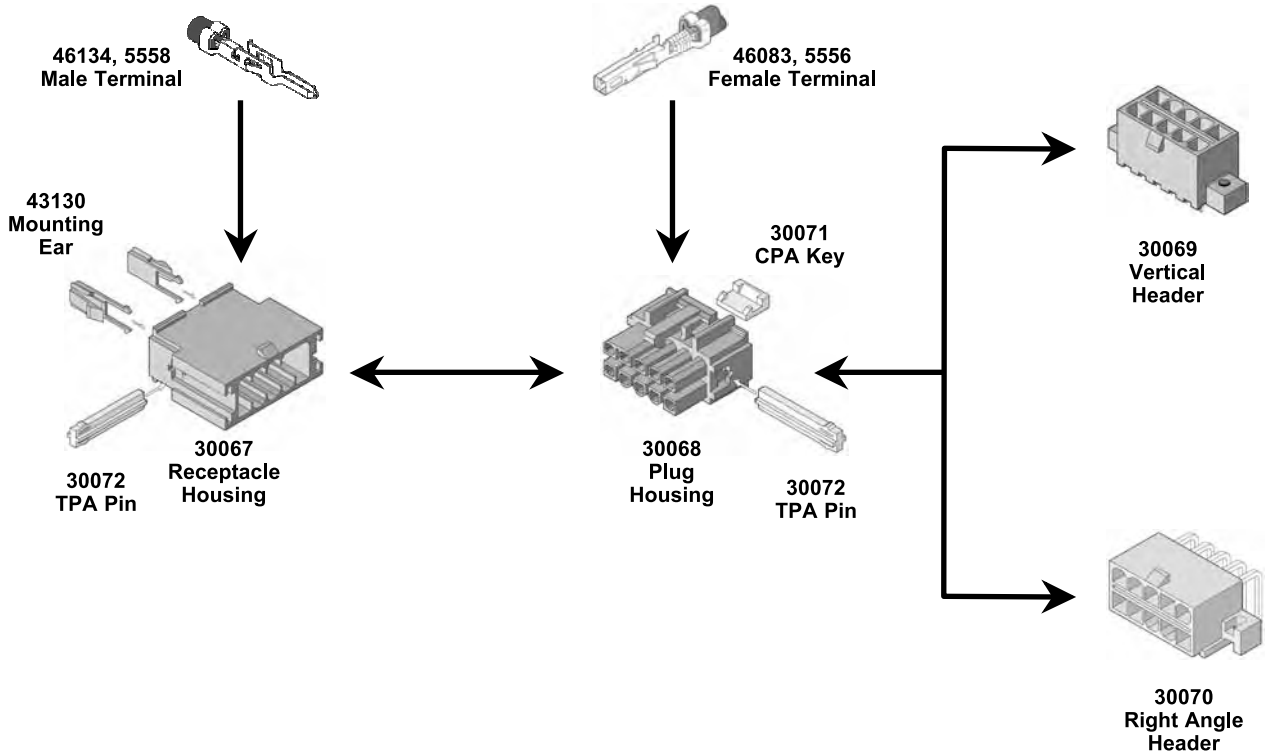

4.20mm (.165") Pitch Mini-Fit TPA™ Crimp Terminal Housing Receptacle

30067
Dual Row
With Secondary Terminal
Retention

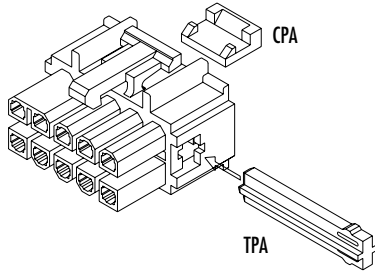

Features and Benefits

- Receptacle housing for wire-to-wire and wire-to-board applications
- Terminal Position Assurance (TPA) allows the terminal to be fully seated in the housing assuring that it will not back out during high vibration applications
- Connector Position Assurance (CPA) assures housing cannot be inadvertently disengaged
- Contrasting color (white) TPA/CPA for high visibility
- TPA and CPA keys are sold individually to meet customer-specific needs

Reference Information

Product Specification: PS-5556-003
UL File No.: E29179
CSA File No.: LR19980
TUV License No.: R75142
Use With: 46083, 45750, and 5556 terminals
Mates With: 30068 housing, 30069 and 30070 headers

Physical

Housing: Black polyester, UL 94V-0

Circuits	Order No.			Lead-free
	Receptacle (30067 Series)	TPA Pin (30072 Series)	CPA Key (30071 Series)	
2	15-97-5021	15-97-9041*	15-97-0071†	Yes
4	15-97-5041			
6	15-97-5061			
8	15-97-5081			
10	15-97-5101			
12	15-97-5121			
16	15-97-5161	15-97-9161		

* The same TPA pin is used for both the 2 and 4 circuit receptacles

† The same CPA key is used for all receptacles, regardless of circuit size

4.20mm (.165") Pitch Mini-Fit TPA™ Header

30069
Vertical, Dual Row
With Flanges, Without Drain Holes

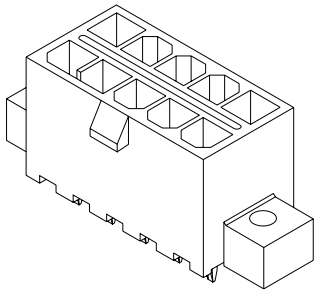

Features and Benefits

- Wire-to-board vertical header with mounting flanges for increased retention
- Positive housing locking ramp
- Fully isolated terminals

Reference Information

Product Specification: PS-5556-003
UL File No.: E29179
CSA File No.: LR19980
TUV License No.: R75142
Mates With: 30067 receptacle

Electrical

Voltage: 600V
Current: 9.0A max. (See applicable product specification.)
Contact Resistance: 10 milliohms max.

Mechanical

Mating Cycles: 30 cycles

Physical

Housing: Black polyester, UL 94V-0
Contact: Brass
Plating: Tin or Select Gold

Circuits	Order No.		Tail Length	Lead-free
	Tin	30µm Select Gold		
2	30069-0211	15-97-7024	3.50mm (.140")	Yes
4	30069-0411	15-97-7044		
6	30069-0611	15-97-7064		
8	30069-0811	15-97-7084		
10	30069-1011	15-97-7104		
12	30069-1211	15-97-7124		
16	30069-1611	15-97-7164		

4.20mm (.165") Pitch Mini-Fit TPA™ Crimp Terminal Housing Plug

30068
Dual Row with Secondary
Terminal Retention

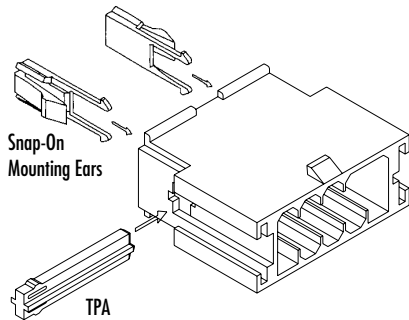

Features and Benefits

- Plug housing for wire-to-wire applications
- Terminal Position Assurance (TPA) allows the terminal to be fully seated in the housing, assuring that it will not back out during high-vibration applications
- TPA key is sold individually to meet customer-specific needs
- Optional snap-on ears for panel mounting
- Contrasting color (white) TPA/CPA for high visibility

Reference Information

Product Specification: PS-5556-003
UL File No.: E29179
CSA File No.: LR19980
TUV License No.: R75142
Use With: 46314, 46012 and 5558 terminals
Mates With: 30067 housing

Physical

Housing: Black polyester, UL 94V-0

Circuits	Order No.			Lead-free
	Plug (30068 Series)	TPA Pin (30072 Series)	Snap-on Mounting Ears	
2	15-97-6021	15-97-9041*	43130-0001†	Yes
4	15-97-6041			
6	15-97-6061			
8	15-97-6081			
16	15-97-6161			

* The same TPA pin is used for both the 2 and 4 circuit plugs

† Two snap-on mounting ears required per plug housing for panel mounting application

4.20mm (.165") Pitch Mini-Fit TPA™ Header

30070
Right Angle, Dual Row
With Flanges

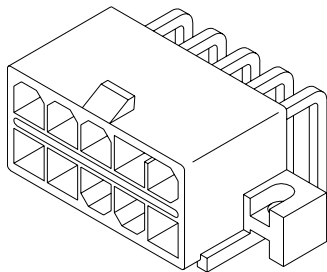

Features and Benefits

- Wire-to-board right angle header with mounting flanges
- Positive housing locking ramp
- Fully isolated contacts

Reference Information

Product Specification: PS-5556-003
UL File No.: E29179
CSA File No.: LR19980
TUV License No.: R75142
Mates With: 30067 receptacle

Electrical

Voltage: 600V
Current: 12.0A max. (See applicable product specification.)
Contact Resistance: 10 milliohms max.

Mechanical

Mating Cycles: 30 cycles

Physical

Housing: Black polyester, UL 94V-0
Contact: Brass
Plating: Tin or Select Gold

Circuits	Order No.		Tail Length	Lead-free
	Tin	30µm Select Gold		
2	30070-0225	30070-0222	3.50mm (.140")	Yes
4	30070-0425	30070-0422		
6	30070-0625	30070-0622		
8	30070-0825	30070-0822		
10	30070-1025	30070-1022		
12	30070-1225	30070-1222		
16	30070-1625	30070-1622		

4.20mm (.165") Pitch Mini-Fit RTC Header

46207

Vertical with and without Pegs

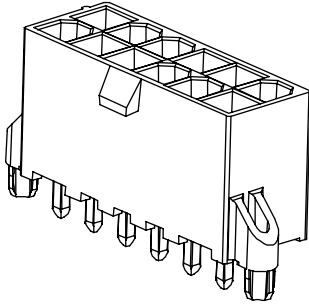

Features and Benefits

- RTC-reflow temperature compatible
- Optional board-mounting pegs provide polarization during placement on the PCB and increased retention during soldering process
- Positive housing locks to mate with Mini-Fit Jr.™ receptacle
- Fully isolated terminals to protect contacts from damage

Reference Information

Product Specification: PS-46207-001
Mates With: 5557 Receptacles

Electrical

Voltage: 600V
Current: 12.0A max. (see applicable product spec)
Contact Resistance: 10 milliohms max.

Mechanical

Durability: 30 cycles

Physical

Housing: LCP, UL 94V-0
Contact: Brass
Plating: Tin

Circuits	Order No.					
	Tail Length = 3.66mm (.144")		Tail Length = 4.46mm (.176")		Tail Length = 5.26mm (.207")	
	With Pegs	Without Pegs	With Pegs	Without Pegs	With Pegs	Without Pegs
4	46207-0004	46207-1004	46207-0104	46207-1104	46207-0204	46207-1204
6	46207-0006	46207-1006	46207-0106	46207-1106	46207-0206	46207-1206
8	46207-0008	46207-1008	46207-0108	46207-1108	46207-0208	46207-1208
10	46207-0010	46207-1010	46207-0110	46207-1110	46207-0210	46207-1210
12	46207-0012	46207-1012	46207-0112	46207-1112	46207-0212	46207-1212
24	46207-0024	46207-1024	46207-0124	46207-1124	46207-0224	46207-1224

4.20mm (.165") Pitch Mini-Fit® PCIe Connector System

Features

- **PCI Express Standard**
Designed to meet the PCI Express™ power connector requirements for high-end graphics card applications.
- **Unique Mating Geometry**
The receptacle housing and the headers feature a custom polarization scheme so they will only mate with each other and no standard Mini-Fit connectors.
- **Positive Locking**
The receptacle housings are equipped with a locking thumbblatch. The headers feature a locking ramp. When mated, the latch and ramp prevent the connectors from accidental unmating.
- **Configuration**
The receptacle housings and right angle headers are designed for wire-to-board applications.
- **Polarizing Pegs**
Polarizing pegs orient the headers on the PCB so they are not inserted backwards and hold the headers to the PCB during the soldering process.
- **Surface Mount Compatible Headers**
The 45732 series headers are designed for reflow solder processing.
- **Lead-free**
All Mini-Fit PCIe connectors have been lead-free since inception.

Specifications

Current Rating: 8.0A max. (16 AWG wire)

Voltage Rating: 600V

Contact Resistance:

10 milliohms max. (initial)

20 milliohms max. (after environmental testing)

Wire Range:

16 AWG (1.80 to 3.10mm insulation OD)

18 to 24 AWG (1.30 to 3.10mm insulation OD)

Plating: Tin Only

PCB Thickness: 1.6mm (0.62")

Applicable PCB Solder Processes: Wave Solder—45558

Reflow—47234

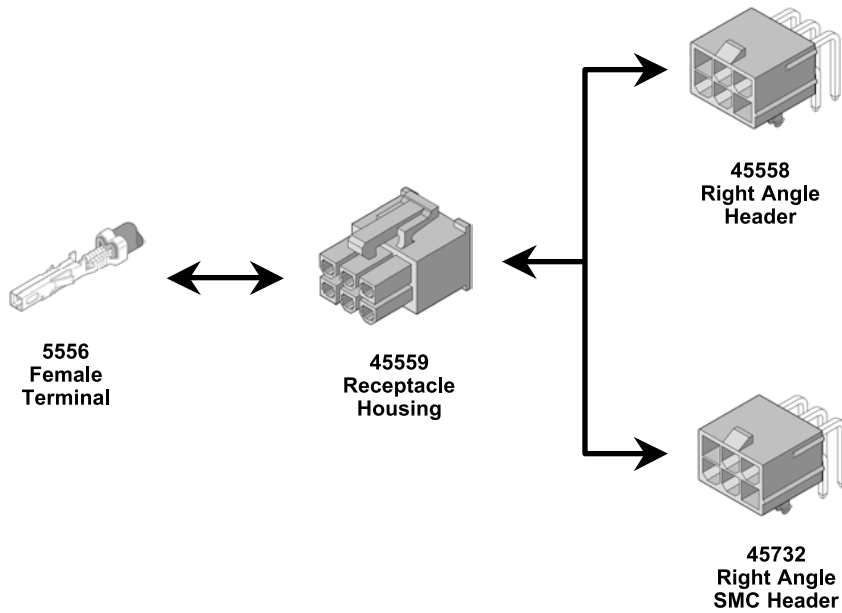

4.20mm (.165") Pitch Mini-Fit® PCI Express* Crimp Terminal Housing Receptacle

45559

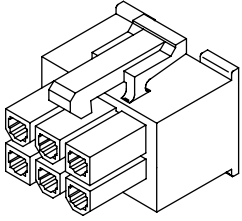

Circuits	Order No.	Lead-Free
6	45559-0002	Yes

*Note: PCI Express is a registered trademark of the Peripheral Component Interchange Special Interest Group (PCI-SIG).

Features and Benefits

- Designed for wire-to-board PCI Express high-end graphics card applications only
- Positive locking latch for secure retention to a header when mated
- Integral pull tabs for ease in unmating
- Fully isolated terminals to protect contacts from damage
- Polarized geometry to prevent mismatching the header and receptacle

Reference Information

Product Specification: PS-45558-001
Mates With: 45558 or 45732 headers only
Use With: 5556 or 46083 terminals
Designed In: Millimeters

Physical

Housing: 6/6 nylon, UL 94V-0

4.20mm (.165") Pitch Mini-Fit® PCI Express* Header

45558
Right Angle

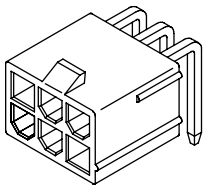

Circuits	Order No.	Tail Length	Lead-Free
6	45558-0002	3.5mm (.140")	Yes

*Note: PCI Express is a registered trademark of the Peripheral Component Interchange Special Interest Group (PCI-SIG).

Features and Benefits

- Designed for wire-to-board PCI Express high-end graphics card applications only
- Positive locking for secure retention to a receptacle when mated
- Locking pegs assure optimum PCB retention during wave-soldering
- Fully isolated terminals to protect contacts from damage
- Polarized geometry to prevent mismatching the header and receptacle

Reference Information

Product Specification: PS-45558-001
Mates With: 45559 receptacle housing only

Electrical

Voltage: 600V
Current: 8.0A max. (See applicable product specification.)
Contact Resistance: 10 milliohms max.

Physical

Housing: 6/6 nylon, UL 94V-0
Contact: Brass
Plating: Tin

4.20mm (.165") Pitch Mini-Fit® PCI Express* Header

45732

**Surface Mount Compatible
Right Angle**

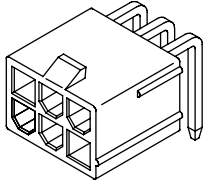

Circuits	Order No.	Lead-Free
6	45732-0001	Yes

*Note: PCI Express is a registered trademark of the Peripheral Component Interchange Special Interest Group (PCI-SIG).

Features and Benefits

- Designed for wire-to-board PCI Express high-end graphics card applications only
- Surface mount process capable
- Positive locking for secure retention to a receptacle when mated
- Friction pegs assure optimum PCB retention during processing
- Fully isolated terminals to protect contacts from damage
- Polarized geometry to prevent mismatching the header and receptacle

Reference Information

Product Specification: PS-45558-0001
Mates With: 45559 receptacle housing only

Electrical

Voltage: 600V
Current: 8.0A max. (See applicable product specification.)
Contact Resistance: 10 milliohms max.

Mechanical

Mating Cycles: 30 cycles

Physical

Housing: LCP, UL 94V-0
Contact: Brass
Plating: Tin

4.20mm (.165") Pitch Mini-Fit® Family Test Plug

44281

Dual Row

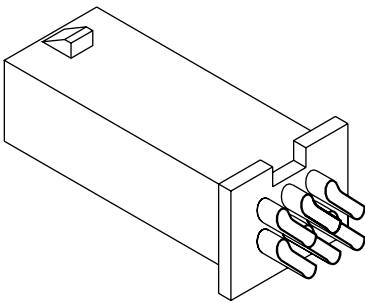

Circuits	Order No.	Lead-free
4	44281-0001	Yes
6	44281-0002	
8	44281-0003	
10	44281-0004	
12	44281-0005	
14	44281-0006	
16	44281-0007	

Important: Mini-Fit test plugs cannot be mated or unmated under load. All current must be shut off prior to mating or unmating. Product is intended for low level continuity testing only.

Features and Benefits

- Spring-loaded male contacts that prevent damage to the female contact
- Rated for 1000s of mating cycles
- Recommended for continuity testing
- Minimizes expense and downtime for test plug replacement

Reference Information

Product Specification: PS-44281-001
UL File No.: E29179
CSA File No.: LR19980
Solder cups accept 22-26 AWG wire

Electrical

Electrical Voltage: 600V

Mechanical

Mating Cycles: 10,000 cycles

Physical

Housing: 4/6 nylon, UL 94V-0
Contact: Beryllium Copper
Plating: Gold

Circuits	Order No.	Lead-free
18	44281-0008	Yes
20	44281-0009	
22	44281-0010	
24	44281-0011	
36	44281-0012	
40	44281-0013	

3.00mm (.118") Pitch Micro-Fit 3.0™ Family



Micro-Fit 3.0

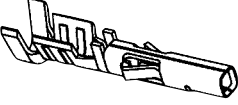
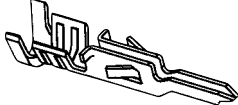

- Fully-isolated contacts
- Full polarization
- Positive locks

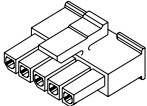
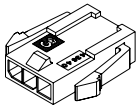
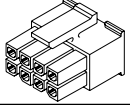
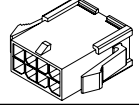
- Up to 5.0A per circuit
- 250V AC rating
- UL 94V-0, CSA, TUV approved

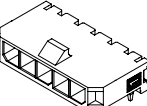
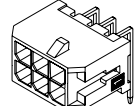
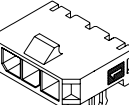
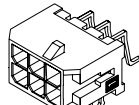
Crimp Terminals					
	Description	Order No.		Wire Gauge	Plating
		Reel	Bag		
	Female Terminal	43030-0001	43030-0007	20-24	Tin
		43030-0004	43030-0010	26-30	
		43030-0002	43030-0008	20-24	15µ" Gold
		43030-0005	43030-0011	26-30	
		43030-0003	43030-0009	20-24	30µ" Gold
		43030-0006	43030-0012	26-30	
	Male Terminal	43031-0001	43031-0007	20-24	Tin
		43031-0004	43031-0010	26-30	
		43031-0002	43031-0008	20-24	15µ" Gold
		43031-0005	43031-0011	26-30	
		43031-0003	43031-0009	20-24	30µ" Gold
		43031-0006	43031-0012	26-30	

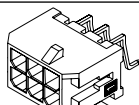
Crimp Housings							
Receptacles (Use with 43030 terminals)				Plugs (Use with 43031 terminals)			
	Description	Order No.	Material		Description	Order No.	Material
	Single Row	43645-XX00	Black Polyester		Single Row Free Hanging	43640-XX01	Black Polyester
					Single Row Panel Mount	43640-XX00	
	Dual Row	43025-XX00	Black Polyester		Dual Row Free Hanging	43020-XX01	Black Polyester
					Dual Row Panel Mount	43020-XX00	

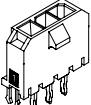
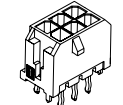
Right Angle Headers									
Single Row	Description	Order No.	Plating	Material	Dual Row	Description	Order No.	Plating	Material
	Surface Mount Compatible with Pegs	43650-XX00	Tin	High Temperature, Black LCP		Surface Mount Compatible with Pegs	43045-XX00	Tin	High Temperature, Black LCP
		43650-XX01	15µ" Gold				43045-XX01	15µ" Gold	
		43650-XX02	30µ" Gold				43045-XX02	30µ" Gold	
	SMT with Solderable Retention Clip	43650-XX09	Tin	High Temperature, Black LCP		SMT with Solderable Retention Clip	43045-XX06	Tin	High Temperature, Black LCP
		43650-XX10	15µ" Gold				43045-XX07	15µ" Gold	
		43650-XX11	30µ" Gold				43045-XX08	30µ" Gold	
	SMT with Solder Tabs	43650-XX12	Tin	High Temperature, Black LCP		SMT with Solder Tabs	43045-XX09	Tin	High Temperature, Black LCP
		43650-XX13	15µ" Gold				43045-XX10	15µ" Gold	
		43650-XX14	30µ" Gold				43045-XX11	30µ" Gold	

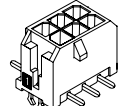
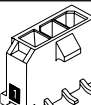
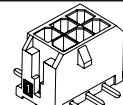
Vertical Headers									
Single Row	Description	Order No.	Plating	Material	Dual Row	Description	Order No.	Plating	Material
	Surface Mount Compatible with Pegs	43650-XX15	Tin	High Temperature, Black LCP		Surface Mount Compatible with Pegs	43045-XX12	Tin	High Temperature, Black LCP
		43650-XX16	15µ" Gold				43045-XX13	15µ" Gold	
		43650-XX17	30µ" Gold				43045-XX14	30µ" Gold	
	SMT with Solderable Retention Clip	43650-XX21	Tin	High Temperature, Black LCP		SMT with Solderable Retention Clip	43045-XX15	Tin	High Temperature, Black LCP
		43650-XX22	15µ" Gold				43045-XX16	15µ" Gold	
		43650-XX23	30µ" Gold				43045-XX17	30µ" Gold	
	SMT with Solder Tabs	43650-XX24	Tin	High Temperature, Black LCP		SMT with Solder Tabs	43045-XX18	Tin	High Temperature, Black LCP
		43650-XX25	15µ" Gold				43045-XX19	15µ" Gold	
		43650-XX26	30µ" Gold				43045-XX20	30µ" Gold	

Replace XX with number of circuits, 02 to 24

E
Power Connectors

3.00mm (.118") Pitch Micro-Fit 3.0™ Family

Micro-Fit 3.0

The Micro-Fit 3.0 is a unique connector system that incorporates many of the features previously found only on large power connectors. These connectors are the perfect choice when you need compact connectors that can carry up to 5.0A of current.

Micro-Fit 3.0 is available in circuit sizes 2 to 24 AWG for wire-to-board and wire-to-wire applications. With more than 500 part numbers and still growing, this expansive product line offers through hole and SMT options. SMT versions are available in tape and reel packaging for robotic placement in the PCB.

Power Connectors

E

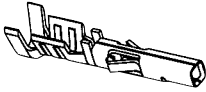
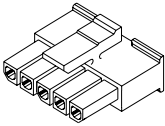
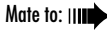
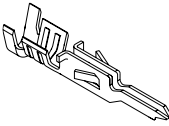
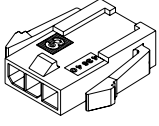
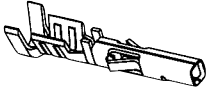
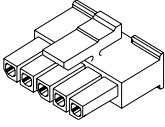
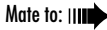
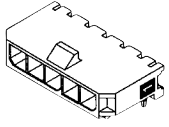
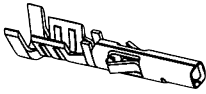
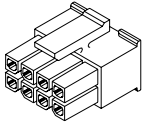
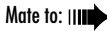
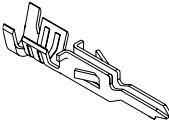
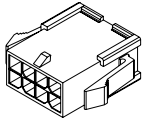
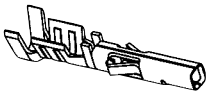
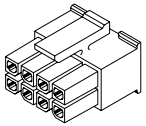
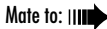
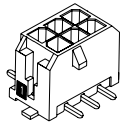
Wire-to-Wire Single Row Connector System						
	and		Mate to: 		and	
Female Terminal 43030		Receptacle 43645		Male Terminal 43031		Plug 43640
Wire-to-Board Single Row Connector System						
	and		Mate to: 		or	Any 43650 Header
Female Terminal 43030		Receptacle 43645		Right Angle SMT with Clips 43650		
Wire-to-Wire Dual Row Connector System						
	and		Mate to: 		and	
Female Terminal 43030		Receptacle 43025		Male Terminal 43031		Plug 43020
Wire-to-Board Dual Row Connector System						
	and		Mate to: 		or	Any 43045 or 44914 Header
Female Terminal 43030		Receptacle 43025		Vertical SMT with Nails 43045		

Micro-Fit 3.0 CPI and Micro-Fit 3.0 BMI CPI

The Micro-Fit 3.0 CPI (Compliant Pin Interface) and Micro-Fit 3.0 BMI CPI (Blind Mate Version with Compliant Pin Interface) are vertical header product extensions featuring press-fit PC tails.

- CPI style press-fit require no soldering to the PCB
- 2.36mm (.093") minimum PCB thickness

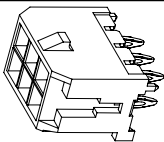
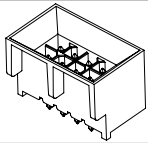
Standard CPI				
	Description	Order No.	Plating	Material
	Standard Vertical CPC	44914-XX01	Tin	High Temperature, Black LCP
		44914-XX02	12µ" Gold	
		44914-XX03	30µ" Gold	
BMI CPI				
	Blind Mate Vertical CPC	45280-XX01	Tin	High Temperature, Black Glass-Filled Nylon
		45280-XX02	12µ" Gold	
		45280-XX03	30µ" Gold	

3.00mm (.118") Pitch Micro-Fit 3.0™ Family

Micro-Fit 3.0 BMI

The Micro-Fit 3.0 BMI (Blind Mate Interface) features an innovative panel mounting design that securely locks the plugs and receptacles in place in the panel cutout, while allowing for removal. The plugs and headers feature a funnel entry to guide the mating receptacle or receptacle header into place. Micro-Fit 3.0, BMI housings and headers mate exclusively with the BMI components shown here.

- Full polarization
- Fully-isolated contacts
- Dual row
- Sizes 4 to 24 circuits
- Up to 5.0A per circuit
- Up to 1500V AC dielectric withstanding voltage
- UL 94V-0, CSA, TUV approved

Crimp Housings

- Use standard Micro-Fit terminals
- Receptacle floats in panel cutout up to 1.27mm (.050") in any direction
- Can be utilized with BMI board-to-board connectors
- Panel Thickness: 1.57mm (.062")

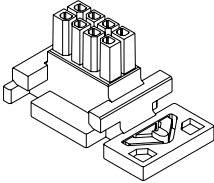
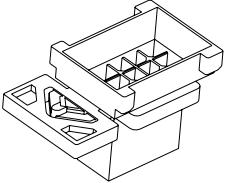
	Description	Order No.	Material
Use with 43030 terminal 	Panel Mount Receptacle	44133-XX00	Black Polyester
Use with 43031 terminal 	Panel Mount Plug	44300-XX00	Black Polyester

Headers

- Can be utilized with BMI board-to-board connectors
- 1.57mm (.062") PCB Thickness
- Surface mount compatible (SMC)
- Black glass-filled nylon housings

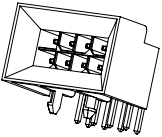
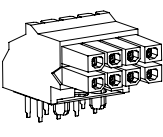
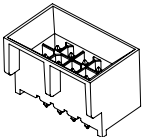
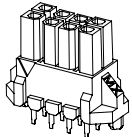
Right Angle							
	Description	Order No.	Plating		Description	Order No.	Plating
	Right Angle Header with Pegs	44428-XX01	Tin		Right Angle Receptacle Header	44764-XX01	Tin
		44428-XX02	15µ" Gold			44764-XX02	15µ" Gold
		44428-XX03	30µ" Gold			44764-XX03	30µ" Gold
Vertical							
	Vertical Header with Pegs	44432-XX01	Tin		Vertical Receptacle Header	44769-XX01	Tin
		44432-XX02	15µ" Gold			44769-XX02	15µ" Gold
		44432-XX03	30µ" Gold			44769-XX03	30µ" Gold

Replace XX with number of circuits, 04 to 24

3.00mm (.118") Pitch Micro-Fit 3.0™ Family

Micro-Fit 3.0 BMI

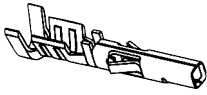
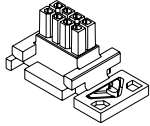
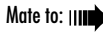
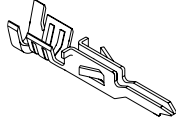
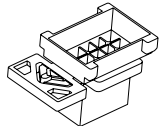
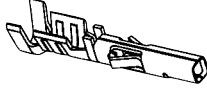
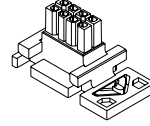
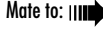
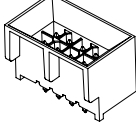
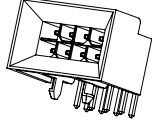
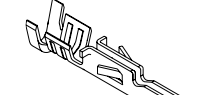
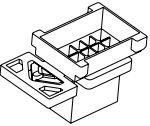
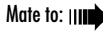
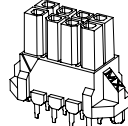
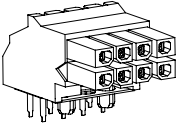
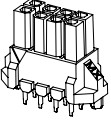
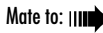
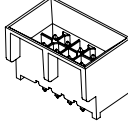
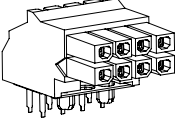
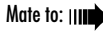
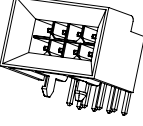
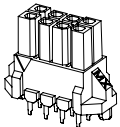
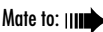
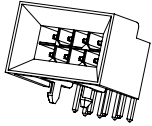
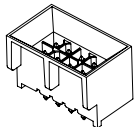
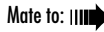
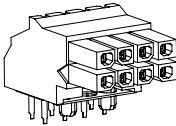
Wire-to-Wire BMI Connector System						
	and		Mate to: 		and	
Female Terminal 43030		Receptacle 44133		Male Terminal 43031		Plug 44300
Wire-to-Board BMI Connector System						
	and		Mate to: 		or	
Female Terminal 43030		Receptacle 44133		Vertical 44432/45280		Right Angle 44428
	and		Mate to: 		or	
Male Terminal 43031		Plug 44300		Vertical 44769		Right Angle 44764
Board-to-Board Dual Row Connector System						
Horizontal Boards						
		Vertical 44769	Mate to: 			Vertical 44432/45280
Coplanar Boards						
		Vertical 44764	Mate to: 			Right Angle 44428
Right Angle Boards						
	Mate to: 		OR		Mate to: 	
Vertical 44769		Right Angle 44428		Vertical 44432/45280		Right Angle 44764

3.00mm (.118") Pitch Micro-Fit 3.0™ Terminal

43030
Female

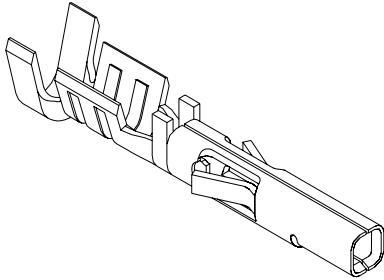

Features and Benefits

- 4 points of contact for optimum reliability
- Box-type spring contact for high normal force
- Locking tang secures terminal in housing

Reference Information

Product Specification: PS-43045/PS-43650
Packaging: Bag or reel
UL File No.: E29179
CSA File No.: LR19980
TUV License No.: R72040445
Use With: 43025, 43645 and 44133 receptacles
Designed In: Millimeters

Electrical

Voltage: 250V
Current: 5.0A max.
Contact Resistance: 30 milliohms max.

Mechanical

Contact Insertion Force: 1.5kgf max. (3.30 lb)
Contact Retention to Housing: 2.5kgf min. (5.50 lb)
Crimping Pull-Out Force:

Wire Gauge (AWG)	Kgf min. (lb)
20	5.8 (13.0)
22	3.6 (8.0)
24	2.2 (5.0)
26	1.3 (3.0)
28	0.9 (2.0)
30	0.7 (1.5)

Mating Force: 0.8kgf max. (1.8 lb) per contact
Normal Force: 275gf max. (0.6 lb)

Physical

Contact: Phosphor Bronze
Plating: Tin or Gold

Wire Size AWG	Plating	Order No.		Lead-free
		Reel	Bag	
20-24	Tin	43030-0001	43030-0007	Yes
26-30		43030-0004	43030-0010	
20-24	15µm Gold	43030-0002	43030-0008	
26-30		43030-0005	43030-0011	
20-24	30µm Gold	43030-0003	43030-0009	
26-30		43030-0006	43030-0012	

3.00mm (.118") Pitch Micro-Fit 3.0™ Terminal

43031
Male

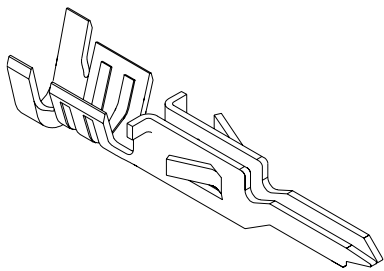

Features and Benefits

- Box-type spring contact for high normal force
- Locking tang secures terminal in housing

Reference Information

Product Specification: PS-43045/PS-43650
Packaging: Bag or reel
UL File No.: E29179
CSA File No.: LR19980
TUV License No.: R72040445
Use With: 43020, 43640 and 44300 plugs
Designed In: Millimeters

Electrical

Voltage: 250V
Current: 5.0A max.
Contact Resistance: 30 milliohms max.

Mechanical

Contact Insertion Force: 1.5kgf max. (3.30 lb)
Contact Retention to Housing: 2.5kgf min. (5.50 lb)
Crimping Pull-Out Force:

Wire Gauge	Kgf min. (lb)
20	5.8 (13.0)
22	3.6 (8.0)
24	2.2 (5.0)
26	1.3 (3.0)
28	0.9 (2.0)
30	0.7 (1.5)

Physical

Contact: Phosphor Bronze
Plating: Tin or Gold

Wire Size AWG	Plating	Order No.		Lead-free
		Reel	Bag	
20-24	Tin	43031-0001	43031-0007	Yes
26-30		43031-0004	43031-0010	
20-24	15µm Gold	43031-0002	43031-0008	
26-30		43031-0005	43031-0011	
20-24	30µm Gold	43031-0003	43031-0009	
26-30		43031-0006	43031-0012	

3.00mm (.118") Pitch Micro-Fit 3.0™ Wire-to-Wire Receptacle

43645
Single Row

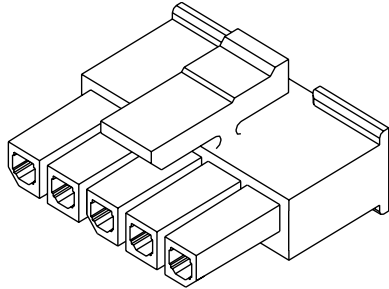

Features and Benefits

- Positive latching to mating headers or plugs
- Fully isolated contacts
- Fully polarized to mating headers and plugs
- Integral pull tabs for ease in unmating

Reference Information

Product Specification: PS-43650
 Packaging: Bag
 UL File No.: E29179
 CSA File No.: LR19980
 TUV License No.: R72040445
 Mates With: 43640 and 43650
 Use With: 43030
 Designed In: Millimeters

Physical

Housing: Polyester, UL 94V-0

Power Connectors

Circuits	Order No.
2	43645-0200
3	43645-0300
4	43645-0400
5	43645-0500
6	43645-0600
7	43645-0700

Circuits	Order No.
8	43645-0800
9	43645-0900
10	43645-1000
11	43645-1100
12	43645-1200

3.00mm (.118") Pitch Micro-Fit 3.0™ Wire-to-Wire Plug

43640
Single Row, with or without
Panel Mount Ears

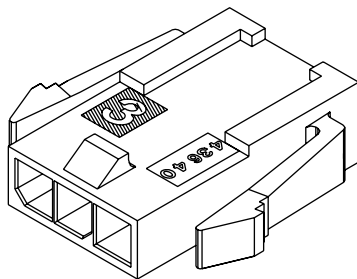

Features and Benefits

- Fully isolated contacts
- Fully polarized to mating receptacle
- Integral pull tabs for ease in unmating
- Optional panel mount ears

Reference Information

Product Specification: PS-43650
 Packaging: Bag
 UL File No.: E29179
 CSA File No.: LR19980
 TUV License No.: R72040445
 Mates With: 43645
 Use With: 43031
 Designed In: Millimeters

Physical

Housing: Polyester, UL 94V-0

Circuits	Order No.	
	Panel Mount	Free Hanging
2	43640-0200	43640-0201
3	43640-0300	43640-0301
4	43640-0400	43640-0401
5	43640-0500	43640-0501
6	43640-0600	43640-0601
7	43640-0700	43640-0701

Circuits	Order No.	
	Panel Mount	Free Hanging
8	43640-0800	43640-0801
9	43640-0900	43640-0901
10	43640-1000	43640-1001
11	43640-1100	43640-1101
12	43640-1200	43640-1201

3.00mm (.118") Pitch Micro-Fit 3.0™ Wire-to-Board Header

43650
Single Row, Vertical
With Solderable Retention Clip

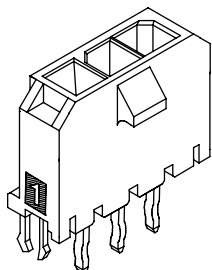

Features and Benefits

- Offset terminal retention for optimum retention to PC board during wave soldering
- Fully polarized to mating receptacle
- Solderable retention clip provides optimum retention to PCB
- Surface Mount Compatible

Reference Information

Product Specification: PS-43650
Packaging: Tray
UL File No.: E29179
CSA File No.: LR19980A
TUV License No.: R72040445
Mates With: 43645
Designed In: Millimeters

Electrical

Voltage: 250V
Current: 5.0A max.
Contact Resistance: 30 milliohms max.
Dielectric Withstanding Voltage: 1500V AC
Insulation Resistance: 1000 Megohms min.

Physical

Housing: LCP, UL 94V-0
Contact: Brass
Plating: Tin or Gold

Circuits	Order No.			Lead-free
	Tin	15µ" Gold	30µ" Gold	
2	43650-0218	43650-0219	43650-0220	Yes
3	43650-0318	43650-0319	43650-0320	
4	43650-0418	43650-0419	43650-0420	
5	43650-0518	43650-0519	43650-0520	
6	43650-0618	43650-0619	43650-0620	
7	43650-0718	43650-0719	43650-0720	
8	43650-0818	43650-0819	43650-0820	
9	43650-0918	43650-0919	43650-0920	
10	43650-1018	43650-1019	43650-1020	
11	43650-1118	43650-1119	43650-1120	
12	43650-1218	43650-1219	43650-1220	

3.00mm (.118") Pitch Micro-Fit 3.0™ Wire-to-Board Header

43650
Single Row, Vertical, SMT
With Solderable Retention Clip

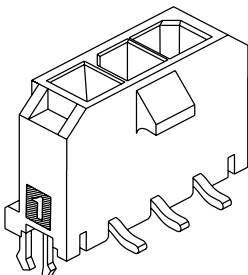

Features and Benefits

- Solderable retention clip provides optimum retention to PCB
- Fully polarized to mating receptacle
- Tape and reel packaging eliminates handling and provides for higher insertion speeds compared to tray packing or hand assembly

Reference Information

Product Specification: PS-43650
Packaging: Tape and reel
UL File No.: E29179
CSA File No.: LR19980A
TUV License No.: R72040445
Mates With: 43645
Designed In: Millimeters

Electrical

Voltage: 250V
Current: 5.0A max.
Contact Resistance: 30 milliohms max.
Dielectric Withstanding Voltage: 1500V AC
Insulation Resistance: 1000 Megohms min.

Physical

Housing: High temperature LCP, UL 94V-0
Contact: Brass
Plating: Tin or Gold

Circuits	Order No.			Lead-free
	Tin	15µ" Gold	30µ" Gold	
2	43650-0221	43650-0222	43650-0223	Yes
3	43650-0321	43650-0322	43650-0323	
4	43650-0421	43650-0422	43650-0423	
5	43650-0521	43650-0522	43650-0523	
6	43650-0621	43650-0622	43650-0623	
7	43650-0721	43650-0722	43650-0723	

Circuits	Order No.			Lead-free
	Tin	15µ" Gold	30µ" Gold	
8	43650-0821	43650-0822	43650-0823	Yes
9	43650-0921	43650-0922	43650-0923	
10	43650-1021	43650-1022	43650-1023	
11	43650-1121	43650-1122	43650-1123	
12	43650-1221	43650-1222	43650-1223	

3.00mm (.118") Pitch Micro-Fit 3.0™ Wire-to-Board Header

43650
Single Row, Vertical, SMT
With Solderable Fitting Nail

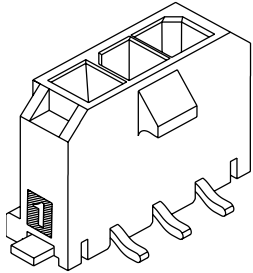

Features and Benefits

- Solder tabs provide retention to PCB
- Fully polarized to mating receptacle
- Tape and reel packaging eliminates handling and provides for higher insertion speeds compared to tray packing or hand assembly

Reference Information

Product Specification: PS-43650
Packaging: Tape and reel
UL File No.: E29179
CSA File No.: LR19980A
TUV License No.: R72040445
Mates With: 43645
Designed In: Millimeters

Electrical

Voltage: 250V
Current: 5.0A max.
Contact Resistance: 30 milliohms max.
Dielectric Withstanding Voltage: 1500V AC
Insulation Resistance: 1000 Megohms min.

Physical

Housing: High temperature LCP, UL 94V-0
Contact: Brass
Plating: Tin or Gold

Circuits	Order No.			Lead-free
	Tin	15µl" Gold	30µl" Gold	
2	43650-0224	43650-0225	43650-0226	Yes
3	43650-0324	43650-0325	43650-0326	
4	43650-0424	43650-0425	43650-0426	
5	43650-0524	43650-0525	43650-0526	
6	43650-0624	43650-0625	43650-0626	
7	43650-0724	43650-0725	43650-0726	

Circuits	Order No.			Lead-free
	Tin	15µl" Gold	30µl" Gold	
8	43650-0824	43650-0825	43650-0826	Yes
9	43650-0924	43650-0925	43650-0926	
10	43650-1024	43650-1025	43650-1026	
11	43650-1124	43650-1125	43650-1126	
12	43650-1224	43650-1225	43650-1226	

3.00mm (.118") Pitch Micro-Fit 3.0™ Wire-to-Board Header

43650
Single Row
Right Angle

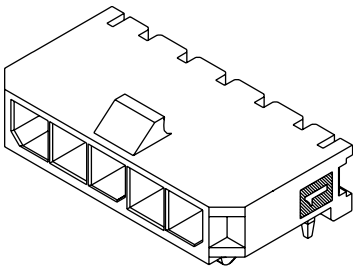

Features and Benefits

- Snap-in peg locks header to PCB for optimum retention
- Fully polarized to mating receptacle
- Surface Mount Compatible

Reference Information

Product Specification: PS-43650
Packaging: Tray
UL File No.: E29179
CSA File No.: LR19980
TUV License No.: R72040445
Mates With: 43645
Designed In: Millimeters

Electrical

Voltage: 250V
Current: 5.0A max.
Contact Resistance: 30 milliohms max.
Dielectric Withstanding Voltage: 1500V AC
Insulation Resistance: 1000 Megohms min.

Physical

Housing: High temperature LCP, UL 94V-0
Contact: Brass
Plating: Tin or Gold

Circuits	Order No.			Lead-free
	Tin	15µl" Gold	30µl" Gold	
2	43650-0200	43650-0201	43650-0202	Yes
3	43650-0300	43650-0301	43650-0302	
4	43650-0400	43650-0401	43650-0402	
5	43650-0500	43650-0501	43650-0502	
6	43650-0600	43650-0601	43650-0602	
7	43650-0700	43650-0701	43650-0702	

Circuits	Order No.			Lead-free
	Tin	15µl" Gold	30µl" Gold	
8	43650-0800	43650-0801	43650-0802	Yes
9	43650-0900	43650-0901	43650-0902	
10	43650-1000	43650-1001	43650-1002	
11	43650-1100	43650-1101	43650-1102	
12	43650-1200	43650-1201	43650-1202	

3.00mm (.118") Pitch Micro-Fit 3.0™ Wire-to-Board Header

43650
Single Row
Right Angle

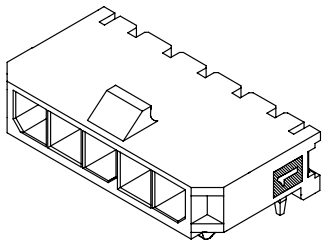

Features and Benefits

- "Offset Terminal Retention" for optimum retention to PC board during wave soldering
- Fully polarized to mating receptacle
- Peg feature provides polarization to PCB
- Surface Mount Compatible

Reference Information

Product Specification: PS-43650
Packaging: Tray
UL File No.: E29179
CSA File No.: LR19980
TUV License No.: R72040445
Mates With: 43645
Designed In: Millimeters

Electrical

Voltage: 250V
Current: 5.0A max.
Contact Resistance: 30 milliohms max.
Dielectric Withstanding Voltage: 1500V AC
Insulation Resistance: 1000 Megohms min.

Mechanical

Insertion Force to PCB: 7.5kgf max. (16.5 lb)

Physical

Housing: High temperature LCP, UL 94V-0
Contact: Brass
Plating: Tin or Gold

Circuits	Order No.						Lead-free
	Standard "OTR" Version			Straight Tail Version			
	Tin	15µm Gold	30µm Gold	Tin	15µm Gold	30µm Gold	
2	43650-0215	43650-0216	43650-0217	43650-0227	43650-0228	43650-0229	Yes
3	43650-0315	43650-0316	43650-0317	43650-0327	43650-0328	43650-0329	
4	43650-0415	43650-0416	43650-0417	43650-0427	43650-0428	43650-0429	
5	43650-0515	43650-0516	43650-0517	43650-0527	43650-0528	43650-0529	
6	43650-0615	43650-0616	43650-0617	43650-0627	43650-0628	43650-0629	
7	43650-0715	43650-0716	43650-0717	43650-0727	43650-0728	43650-0729	
8	43650-0815	43650-0816	43650-0817	43650-0827	43650-0828	43650-0829	
9	43650-0915	43650-0916	43650-0917	43650-0927	43650-0928	43650-0929	
10	43650-1015	43650-1016	43650-1017	43650-1027	43650-1028	43650-1029	
11	43650-1115	43650-1116	43650-1117	43650-1127	43650-1128	43650-1129	
12	43650-1215	43650-1216	43650-1217	43650-1227	43650-1228	43650-1229	

3.00mm (.103") Pitch Micro-Fit 3.0™ Wire-to-Board Header

43650
Single Row, Right Angle
With Solderable Retention Clip

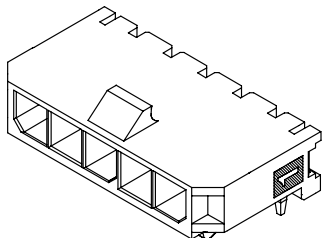

Features and Benefits

- Solderable clip provides optimum retention to PCB
- Fully polarized to mating receptacle
- Surface Mount Compatible

Reference Information

Product Specification: PS-43650
Packaging: Tray
UL File No.: E29179
CSA File No.: LR04980A
TUV License No.: R72040445
Mates With: 43645
Designed In: Millimeters

Electrical

Voltage: 250V
Current: 5.0A max.
Contact Resistance: 30 milliohms max.
Dielectric Withstanding Voltage: 1500V AC
Insulation Resistance: 1000 Megohms min.

Mechanical

Insertion Force to PCB: 7.5kgf max. (16.5 lb)

Physical

Housing: High temperature LCP, UL 94V-0
Contact: Brass
Plating: Tin or Gold

Circuits	Order No.			Lead-free
	Tin	15µm Gold	30µm Gold	
2	43650-0203	43650-0204	43650-0205	Yes
3	43650-0303	43650-0304	43650-0305	
4	43650-0403	43650-0404	43650-0405	
5	43650-0503	43650-0504	43650-0505	
6	43650-0603	43650-0604	43650-0605	
7	43650-0703	43650-0704	43650-0705	
8	43650-0803	43650-0804	43650-0805	
9	43650-0903	43650-0904	43650-0905	
10	43650-1003	43650-1004	43650-1005	
11	43650-1103	43650-1104	43650-1105	
12	43650-1203	43650-1204	43650-1205	

3.00mm (.118") Pitch Micro-Fit 3.0™ Wire-to-Board Header

43650
Single Row, Right Angle, SMT
With Solderable Retention Clip

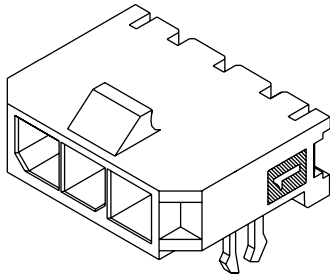

Features and Benefits

- Solderable retention clip provides optimum retention to PCB
- Fully polarized to mating receptacle
- Tape and reel packaging eliminates handling and provides higher insertion speed compared to tray packing or hand assembly

Reference Information

Product Specification: PS-43650
Packaging: Tape and reel
UL File No.: E29179
CSA File No.: LR19980A
TUV License No.: R72040445
Mates With: 43645
Designed In: Millimeters

Electrical

Voltage: 250V
Current: 5.0A max.
Contact Resistance: 30 milliohms max.
Dielectric Withstanding Voltage: 1500V AC
Insulation Resistance: 1000 Megohms min.

Mechanical

Insertion Force to PCB: 7.5kgf max. (16.5 lb)

Physical

Housing: High temperature LCP, UL 94V-0
Contact: Brass
Plating: Tin or Gold

Circuits	Order No.			Lead-free
	Tin	15µm Gold	30µm Gold	
2	43650-0209	43650-0210	43650-0211	Yes
3	43650-0309	43650-0310	43650-0311	
4	43650-0409	43650-0410	43650-0411	
5	43650-0509	43650-0510	43650-0511	
6	43650-0609	43650-0610	43650-0611	
7	43650-0709	43650-0710	43650-0711	

Circuits	Order No.			Lead-free
	Tin	15µm Gold	30µm Gold	
8	43650-0809	43650-0810	43650-0811	Yes
9	43650-0909	43650-0910	43650-0911	
10	43650-1009	43650-1010	43650-1011	
11	43650-1109	43650-1110	43650-1111	
12	43650-1209	43650-1210	43650-1211	

3.00mm (.118") Pitch Micro-Fit 3.0™ Wire-to-Board Header

43650
Single Row, Right Angle, SMT
With Solderable Fitting Nail

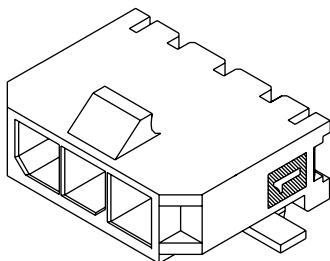

Features and Benefits

- Solder tabs provide retention to PCB
- Fully polarized to mating receptacle
- Tape and reel packaging eliminates handling and provides higher insertion speeds compared to tray packing or hand assembly

Reference Information

Product Specification: PS-43650
Packaging: Tape and reel for robotic placement
UL File No.: E29179
CSA File No.: LR19980A
TUV License No.: R72040445
Mates With: 43645
Designed In: Millimeters

Electrical

Voltage: 250V
Current: 5.0A max.
Contact Resistance: 30 milliohms max.
Dielectric Withstanding Voltage: 1500V AC
Insulation Resistance: 1000 Megohms min.

Physical

Housing: High temperature LCP, UL 94V-0
Contact: Brass
Plating: Tin or Gold

Circuits	Order No.			Lead-free
	Tin	15µm Gold	30µm Gold	
2	43650-0212	43650-0213	43650-0214	Yes
3	43650-0312	43650-0313	43650-0314	
4	43650-0412	43650-0413	43650-0414	
5	43650-0512	43650-0513	43650-0514	
6	43650-0612	43650-0613	43650-0614	
7	43650-0712	43650-0713	43650-0714	

Circuits	Order No.			Lead-free
	Tin	15µm Gold	30µm Gold	
8	43650-0812	43650-0813	43650-0814	Yes
9	43650-0912	43650-0913	43650-0914	
10	43650-1012	43650-1013	43650-1014	
11	43650-1112	43650-1113	43650-1114	
12	43650-1212	43650-1213	43650-1214	

3.00mm (.118") Pitch Micro-Fit 3.0™ Wire-to-Wire Receptacle

43025
Dual Row

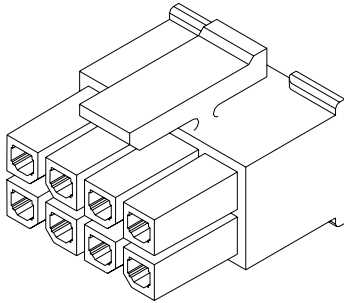

Features and Benefits

- Positive latching to mating headers or plugs
- Fully isolated contacts
- Fully polarized to mating headers and plugs
- Integral pull tabs for ease in unmating

Reference Information

Product Specification: PS-43045
 Packaging: Bag
 UL File No.: E29179
 CSA File No.: LR19980
 TUV License No.: R72040445
 Mates With: 43020, 43045 and 44914
 Use With: 43030
 Designed In: Millimeters

Physical

Housing: Polyester, UL 94V-0

Circuits	Order No.
2	43025-0200
4	43025-0400
6	43025-0600
8	43025-0800
10	43025-1000
12	43025-1200

Circuits	Order No.
14	43025-1400
16	43025-1600
18	43025-1800
20	43025-2000
22	43025-2200
24	43025-2400

3.00mm (.118") Pitch Micro-Fit 3.0™ Wire-to-Wire Plug

43020
Dual Row, with or without
Panel Mount Ears

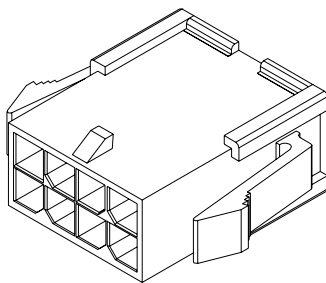

Features and Benefits

- Fully isolated contacts
- Fully polarized to mating receptacle
- Integral pull tabs for ease in unmating
- Optional panel mount ears

Reference Information

Product Specification: PS-43045
 Packaging: Bag
 UL File No.: E29179
 CSA File No.: LR19980
 TUV License No.: R72040445
 Mates With: 43025
 Use With: 43031
 Designed In: Millimeters

Physical

Housing: Polyester, UL 94V-0

Circuits	Order No.	
	Panel Mount	Free Hanging
2	43020-0200	43020-0201
4	43020-0400	43020-0401
6	43020-0600	43020-0601
8	43020-0800	43020-0801
10	43020-1000	43020-1001
12	43020-1200	43020-1201

Circuits	Order No.	
	Panel Mount	Free Hanging
14	43020-1400	43020-1401
16	43020-1600	43020-1601
18	43020-1800	43020-1801
20	43020-2000	43020-2001
22	43020-2200	43020-2201
24	43020-2400	43020-2401

3.00mm (.118") Pitch Micro-Fit 3.0™ Wire-to-Board Header

43045
Dual Row
Vertical

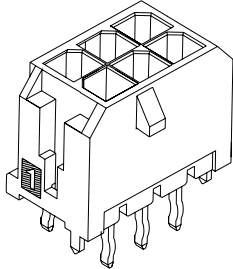

Features and Benefits

- "Offset Terminal Retention" for optimum retention to PC board during wave soldering
- Fully polarized to mating receptacle
- Peg feature provides polarization to PCB
- Surface Mount Compatible

Reference Information

Product Specification: PS-43045
Packaging: Tray
UL File No.: E29179
CSA File No.: LR19980
TUV License No.: R72040445
Mates With: 43025
Designed In: Millimeters

Electrical

Voltage: 250V
Current: 5.0A max.
Contact Resistance: 30 milliohms max.
Dielectric Withstanding Voltage: 1500V AC
Insulation Resistance: 1000 Megohms min.

Mechanical

Insertion Force to PCB: 7.5kgf max. (16.5 lb)

Physical

Housing: High temperature LCP, UL 94V-0
Contact: Brass
Plating: Tin or Gold

Circuits	Order No.						Lead-free
	Standard "OTR" Version			Straight Tail Version			
	Tin	15µ" Gold	30µ" Gold	Tin	15µ" Gold	30µ" Gold	
2	43045-0212	43045-0213	43045-0214	43045-0227	43045-0228	43045-0229	Yes
4	43045-0412	43045-0413	43045-0414	43045-0427	43045-0428	43045-0429	
6	43045-0612	43045-0613	43045-0614	43045-0627	43045-0628	43045-0629	
8	43045-0812	43045-0813	43045-0814	43045-0827	43045-0828	43045-0829	
10	43045-1012	43045-1013	43045-1014	43045-1027	43045-1028	43045-1029	
12	43045-1212	43045-1213	43045-1214	43045-1227	43045-1228	43045-1229	
14	43045-1412	43045-1413	43045-1414	43045-1427	43045-1428	43045-1429	
16	43045-1612	43045-1613	43045-1614	43045-1627	43045-1628	43045-1629	
18	43045-1812	43045-1813	43045-1814	43045-1827	43045-1828	43045-1829	
20	43045-2012	43045-2013	43045-2014	43045-2027	43045-2028	43045-2029	
22	43045-2212	43045-2213	43045-2214	43045-2227	43045-2228	43045-2229	
24	43045-2412	43045-2413	43045-2414	43045-2427	43045-2428	43045-2429	

3.00mm (.118") Micro-Fit 3.0™ Wire-to-Board Header

43045
Dual Row, Vertical, SMT
With Solderable Retention Clip

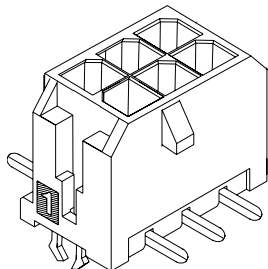

Features and Benefits

- Solderable retention clip provides optimum retention to PCB
- Fully polarized to mating receptacle
- Tape and reel packaging eliminates handling and provides for higher insertion speeds compared to tray packing or hand assembly

Reference Information

Product Specification: PS-43045
Packaging: Tape and reel
UL File No.: E29179
CSA File No.: LR19980
TUV License No.: R72040445
Mates With: 43025
Designed In: Millimeters

Electrical

Voltage: 250V
Current: 5.0A max.
Contact Resistance: 30 milliohms max.
Dielectric Withstanding Voltage: 1500V AC
Insulation Resistance: 1000 Megohms min.

Mechanical

Insertion Force to PCB: 7.5kgf max. (16.5 lb)

Physical

Housing: High temperature LCP, UL 94V-0
Contact: Brass
Plating: Tin or Gold

Circuits	Order No.			Lead-free
	Tin	15µ" Gold	30µ" Gold	
2	43045-0215	43045-0216	43045-0217	Yes
4	43045-0415	43045-0416	43045-0417	
6	43045-0615	43045-0616	43045-0617	
8	43045-0815	43045-0816	43045-0817	
10	43045-1015	43045-1016	43045-1017	
12	43045-1215	43045-1216	43045-1217	

Circuits	Order No.			Lead-free
	Tin	15µ" Gold	30µ" Gold	
14	43045-1415	43045-1416	43045-1417	Yes
16	43045-1615	43045-1616	43045-1617	
18	43045-1815	43045-1816	43045-1817	
20	43045-2015	43045-2016	43045-2017	
22	43045-2215	43045-2216	43045-2217	
24	43045-2415	43045-2416	43045-2417	

3.00mm (.118") Pitch Micro-Fit 3.0™ Wire-to-Board Header

43045
Dual Row, Vertical, SMT
With Solderable Fitting Nail

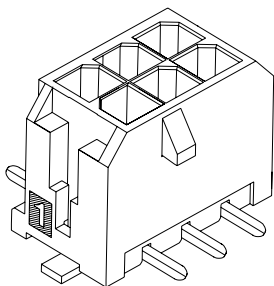

Features and Benefits

- Solder tabs provide retention to PCB
- Fully polarized to mating receptacle
- Tape and reel packaging eliminates handling and provides for higher PCB board placement speeds compared to tray packing or hand assembly

Reference Information

Product Specification: PS-43045
Packaging: Tape and reel
UL File No.: E29179
CSA File No.: LR19980
TUV License No.: R72040445
Mates With: 43025
Designed In: Millimeters

Electrical

Voltage: 250V
Current: 5.0A max.
Contact Resistance: 30 milliohms max.
Dielectric Withstanding Voltage: 1500V AC
Insulation Resistance: 1000 Megohms min.

Physical

Housing: High temperature LCP, UL 94V-0
Contact: Brass
Plating: Tin or Gold

Circuits	Order No.			Lead-free
	Tin	15µ" Gold	30µ" Gold	
2	43045-0218	43045-0219	43045-0220	Yes
4	43045-0418	43045-0419	43045-0420	
6	43045-0618	43045-0619	43045-0620	
8	43045-0818	43045-0819	43045-0820	
10	43045-1018	43045-1019	43045-1020	
12	43045-1218	43045-1219	43045-1220	

Circuits	Order No.			Lead-free
	Tin	15µ" Gold	30µ" Gold	
14	43045-1418	43045-1419	43045-1420	Yes
16	43045-1618	43045-1619	43045-1620	
18	43045-1818	43045-1819	43045-1820	
20	43045-2018	43045-2019	43045-2020	
22	43045-2218	43045-2219	43045-2220	
24	43045-2418	43045-2419	43045-2420	

3.00mm (.118") Pitch Micro-Fit 3.0™ Wire-to-Board Header

43045
Dual Row
Right Angle

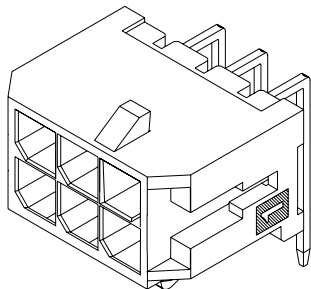

Features and Benefits

- Snap-in peg locks header to PCB for optimum retention
- Fully polarized to mating receptacle
- Surface Mount Compatible

Reference Information

Product Specification: PS-43045
Packaging: Tray
UL File No.: E29179
CSA File No.: LR19980
TUV License No.: R72040445
Mates With: 43025
Designed In: Millimeters

Electrical

Voltage: 250V
Current: 5.0A max.
Contact Resistance: 30 milliohms max.
Dielectric Withstanding Voltage: 1500V AC
Insulation Resistance: 1000 Megohms min.

Mechanical

Insertion Force to PCB: 7.5kgf max. (16.5 lb)

Physical

Housing: High temperature LCP, UL 94V-0
Contact: Brass
Plating: Tin or Gold

Circuits	Order No.			Lead-free
	Tin	15µ" Gold	30µ" Gold	
2	43045-0200	43045-0201	43045-0202	Yes
4	43045-0400	43045-0401	43045-0402	
6	43045-0600	43045-0601	43045-0602	
8	43045-0800	43045-0801	43045-0802	
10	43045-1000	43045-1001	43045-1002	
12	43045-1200	43045-1201	43045-1202	

Circuits	Order No.			Lead-free
	Tin	15µ" Gold	30µ" Gold	
14	43045-1400	43045-1401	43045-1402	Yes
16	43045-1600	43045-1601	43045-1602	
18	43045-1800	43045-1801	43045-1802	
20	43045-2000	43045-2001	43045-2002	
22	43045-2200	43045-2201	43045-2202	
24	43045-2400	43045-2401	43045-2402	

3.00mm (.118") Pitch Micro-Fit 3.0™ Wire-to-Board Header

43045
Dual Row, Right Angle, SMT
With Solderable Retention Clip

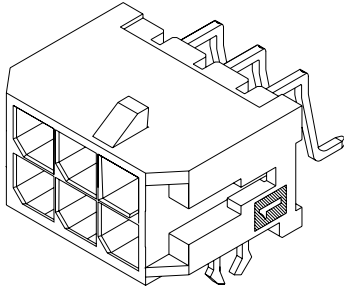

Features and Benefits

- Solderable retention clip provides optimum retention to PCB
- Fully polarized to mating receptacle
- Tape and reel packaging eliminates handling and provides higher insertion speed compared to tray packing or hand assembly

Reference Information

Product Specification: PS-43045
Packaging: Tape and reel
UL File No.: E29179
CSA File No.: LR19980
TUV License No.: R72040445
Mates With: 43025
Designed In: Millimeters

Electrical

Voltage: 250V
Current: 5.0A max.
Contact Resistance: 30 milliohms max.
Dielectric Withstanding Voltage: 1500V AC
Insulation Resistance: 1000 Megohms min.

Mechanical

Insertion Force to PCB: 7.5kgf max. (16.5 lb)

Physical

Housing: High temperature LCP, UL 94V-0
Contact: Brass
Plating: Tin or Gold

Circuits	Order No.			Lead-free
	Tin	15µm Gold	30µm Gold	
2	43045-0206	43045-0207	43045-0208	Yes
4	43045-0406	43045-0407	43045-0408	
6	43045-0606	43045-0607	43045-0608	
8	43045-0806	43045-0807	43045-0808	
10	43045-1006	43045-1007	43045-1008	
12	43045-1206	43045-1207	43045-1208	

Circuits	Order No.			Lead-free
	Tin	15µm Gold	30µm Gold	
14	43045-1406	43045-1407	43045-1408	Yes
16	43045-1606	43045-1607	43045-1608	
18	43045-1806	43045-1807	43045-1808	
20	43045-2006	43045-2007	43045-2008	
22	43045-2206	43045-2207	43045-2208	
24	43045-2406	43045-2407	43045-2408	

3.00mm (.118") Pitch Micro-Fit 3.0™ Wire-to-Board Header

43045
Dual Row, Right Angle, SMT
With Solderable Fitting Nail

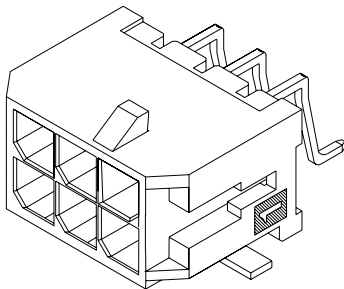

Features and Benefits

- Solder tabs provide retention to PCB
- Fully polarized to mating receptacle
- Tape and reel packaging eliminates handling and provides higher insertion speeds compared to tray packing or hand assembly

Reference Information

Product Specification: PS-43045
Packaging: Tape and reel
UL File No.: E29179
CSA File No.: LR19980
TUV License No.: R72040445
Mates With: 43025
Designed In: Millimeters

Electrical

Voltage: 250V
Current: 5.0A max.
Contact Resistance: 30 milliohms max.
Dielectric Withstanding Voltage: 1500V AC
Insulation Resistance: 1000 Megohms min.

Physical

Housing: High temperature LCP, UL 94V-0
Contact: Brass
Plating: Tin or Gold

Circuits	Order No.			Lead-free
	Tin	15µm Gold	30µm Gold	
2	43045-0209	43045-0210	43045-0211	Yes
4	43045-0409	43045-0410	43045-0411	
6	43045-0609	43045-0610	43045-0611	
8	43045-0809	43045-0810	43045-0811	
10	43045-1009	43045-1010	43045-1011	
12	43045-1209	43045-1210	43045-1211	

Circuits	Order No.			Lead-free
	Tin	15µm Gold	30µm Gold	
14	43045-1409	43045-1410	43045-1411	Yes
16	43045-1609	43045-1610	43045-1611	
18	43045-1809	43045-1810	43045-1811	
20	43045-2009	43045-2010	43045-2011	
22	43045-2209	43045-2210	43045-2211	
24	43045-2409	43045-2410	43045-2411	

3.00mm (.118") Pitch Micro-Fit 3.0™ Test Plug

44242
Dual Row

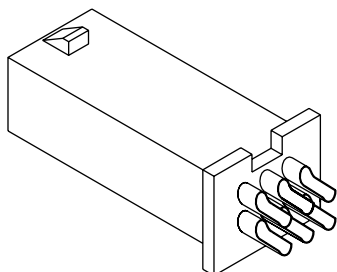

Features and Benefits

- Rated for 10,000 mating cycles
- Minimal expense and downtime for test plug replacement
- Gold-plated, beryllium copper contacts are precision made for long life
- To be used for continuity testing only*
- Micro-Fit dual row sizes available for every application: 4 to 24 circuits**
- Mismatching prevented because plug is fully polarized to mating receptacle

Reference Information

Product Specification: PS-43045
Packaging: Box
Mates With: 43025, 43645 and 44133
Designed In: Inches

Electrical

Current: 2.5A max.
Contact Resistance: 35 milliohms max.

Mechanical

Contact Retention to Housing: 5.0kgf
Durability: 10,000 cycles

Physical

Housing: Black LCP, UL 94V-0
Contact: Heat-treated Beryllium Copper
Plating: Gold over hard Nickel

Circuits	Order No.	Lead-free
4	44242-0001	Yes
6	44242-0002	
8	44242-0003	
10	44242-0004	
12	44242-0005	
14	44242-0006	

Circuits	Order No.	Lead-free
16	44242-0007	Yes
18	44242-0008	
20	44242-0009	
22	44242-0010	
24	44242-0011	

* Important: Micro-Fit test headers cannot be mated or unmated under load. All current must be shut off prior to mating or unmating.

**To test single row receptacles (43645), use test plugs which have twice as many circuits as the receptacles to be tested.

3.00mm (.118") Pitch Micro-Fit 3.0 BMI™ Board-to-Board and Wire-to-Board Receptacle Header

44769
Dual Row, Vertical

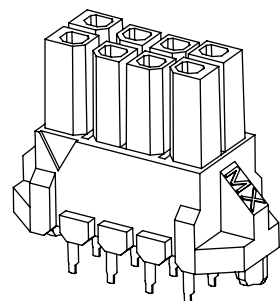

Features and Benefits

- 4 to 24 circuits for design flexibility
- Fully isolated contacts prevent terminal damage
- Fully polarized to prevent mismatching

Reference Information

Product Specification: PS-44300
Packaging: Tray
UL File No.: E29179
CSA File No.: LR19980A
TUV File No.: R72040445
Mates With: 44300, 44428, 44432 and 45280
Designed In: Millimeters

Electrical

Voltage: 250V
Current: 5.0A max.
Contact Resistance: 30 milliohms max.
Dielectric Withstanding Voltage: 1500V AC

Mechanical

Insertion Force to PCB: 7.5kgf max. (16.5 lb)
Durability: 30 cycles

Physical

Housing: Glass-filled nylon, UL 94V-0
Contact: Brass
Plating: Contact Area—Tin or Gold
Solder Tail Area—Tin
Underplating—Nickel
PCB Thickness: 1.57mm (.062")

Circuits	Order No.			Lead-free
	Tin	15µl" Gold	30µl" Gold	
4	44769-0401	44769-0402	44769-0403	Yes
6	44769-0601	44769-0602	44769-0603	
8	44769-0801	44769-0802	44769-0803	
10	44769-1001	44769-1002	44769-1003	
12	44769-1201	44769-1202	44769-1203	
14	44769-1401	44769-1402	44769-1403	
16	44769-1601	44769-1602	44769-1603	
18	44769-1801	44769-1802	44769-1803	
20	44769-2001	44769-2002	44769-2003	
22	44769-2201	44769-2202	44769-2203	
24	44769-2401	44769-2402	44769-2403	

3.00mm (.118") Pitch Micro-Fit 3.0 BMI™ Board-to-Board and Wire-to-Board Receptacle Header

44764

Dual Row, Right Angle

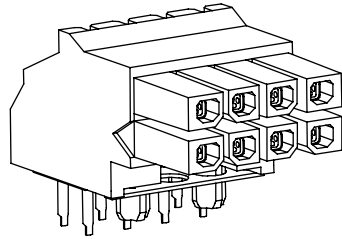

Features and Benefits

- 4 to 24 circuits for design flexibility
- Fully isolated contacts prevent terminal damage
- Fully polarized to prevent mismatching

Reference Information

Product Specification: PS-44300
Packaging: Tray
UL File No.: E29179
CSA File No.: LR19980A
TUV File No.: R72040445
Mates With: 44300, 44428, 44432 and 45280
Designed In: Millimeters

Electrical

Voltage: 250V
Current: 5.0A max.
Contact Resistance: 30 milliohms max.
Dielectric Withstanding Voltage: 1500V AC

Mechanical

Insertion Force to PCB: 7.5kgf max. (16.5 lb)
Durability: 30 cycles

Physical

Housing: Glass-filled nylon, UL 94V-0
Contact: Brass
Plating: Contact Area—Tin or Gold
Solder Tail Area—Tin
Underplating—Nickel
PCB Thickness: 1.57mm (.062")

Circuits	Order No.			Lead-free
	Tin	15 μ m Gold	30 μ m Gold	
4	44764-0401	44764-0402	44764-0403	Yes
6	44764-0601	44764-0602	44764-0603	
8	44764-0801	44764-0802	44764-0803	
10	44764-1001	44764-1002	44764-1003	
12	44764-1201	44764-1202	44764-1203	
14	44764-1401	44764-1402	44764-1403	
16	44764-1601	44764-1602	44764-1603	
18	44764-1801	44764-1802	44764-1803	
20	44764-2001	44764-2002	44764-2003	
22	44764-2201	44764-2202	44764-2203	
24	44764-2401	44764-2402	44764-2403	

3.00mm (.118") Pitch Micro-Fit 3.0 BMI™ Board-to-Board and Wire-to-Board Header

44432

Dual Row, Vertical

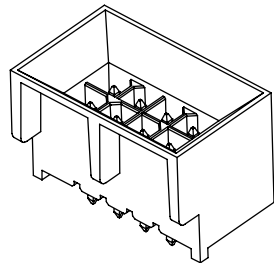

Features and Benefits

- 4 to 24 circuits for design flexibility
- Fully isolated contacts prevent terminal damage
- Fully polarized to prevent mismatching

Reference Information

Product Specification: PS-44300
Packaging: Tray
UL File No.: E29179
CSA File No.: LR19980A
TUV File No.: R72040445
Mates With: 44133, 44764 and 44769
Designed In: Millimeters

Electrical

Voltage: 250V
Current: 5.0A max.
Contact Resistance: 30 milliohms max.
Dielectric Withstanding Voltage: 1500V AC

Mechanical

Insertion Force to PCB: 7.5kgf max. (16.5 lb)
Durability: 30 cycles

Physical

Housing: Glass-filled nylon, UL 94V-0
Contact: Brass
Plating: Contact Area—Tin or Gold
Solder Tail Area—Tin
Underplating—Nickel
PCB Thickness: 1.57mm (.062")

Circuits	Order No.			Lead-free
	Tin	15 μ m Gold	30 μ m Gold	
4	44432-0401	44432-0402	44432-0403	Yes
6	44432-0601	44432-0602	44432-0603	
8	44432-0801	44432-0802	44432-0803	
10	44432-1001	44432-1002	44432-1003	
12	44432-1201	44432-1202	44432-1203	
14	44432-1401	44432-1402	44432-1403	
16	44432-1601	44432-1602	44432-1603	
18	44432-1801	44432-1802	44432-1803	
20	44432-2001	44432-2002	44432-2003	
22	44432-2201	44432-2202	44432-2203	
24	44432-2401	44432-2402	44432-2403	

3.00mm (.118") Pitch Micro-Fit 3.0 BMI™ Board-to-Board and Wire-to-Board Header

44428
Dual Row, Right Angle

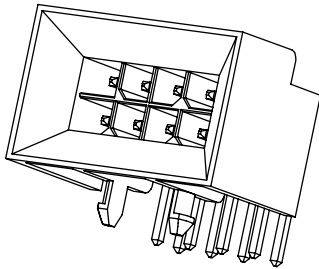

Features and Benefits

- 4 to 24 circuits for design flexibility
- Fully isolated contacts prevent terminal damage
- Fully polarized to prevent mismatching

Reference Information

Product Specification: PS-44300
Packaging: Tray
UL File No.: E29179
CSA File No.: LR19980A
TUV File No.: R72040445
Mates With: 44133, 44764 and 44769
Designed In: Millimeters

Electrical

Voltage: 250V
Current: 5.0A max.
Contact Resistance: 30 milliohms max.
Dielectric Withstanding Voltage: 1500V AC

Mechanical

Insertion Force to PCB: 7.5kgf max. (16.5 lb)
Durability: 30 cycles

Physical

Housing: Glass-filled nylon, UL 94V-0
Contact: Brass
Plating: Contact Area—Tin or Gold
Solder Tail Area—Tin
Underplating—Nickel
PCB Thickness: 1.57mm (.062")

Circuits	Order No.			Lead-free
	Tin	15µ" Gold	30µ" Gold	
4	44428-0401	44428-0402	44428-0403	Yes
6	44428-0601	44428-0602	44428-0603	
8	44428-0801	44428-0802	44428-0803	
10	44428-1001	44428-1002	44428-1003	
12	44428-1201	44428-1202	44428-1203	
14	44428-1401	44428-1402	44428-1403	
16	44428-1601	44428-1602	44428-1603	
18	44428-1801	44428-1802	44428-1803	
20	44428-2001	44428-2002	44428-2003	
22	44428-2201	44428-2202	44428-2203	
24	44428-2401	44428-2402	44428-2403	

3.00mm (.118") Micro-Fit 3.0 BMI™ Panel-to-Panel Receptacle

44133
Dual Row

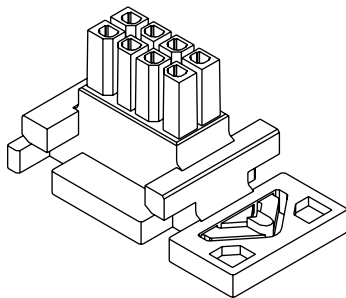

Features and Benefits

- Receptacle floats in panel cutout up to 1.27mm (.050") in any direction
- 4 to 24 circuits for design flexibility
- Use standard Micro-Fit 3.0 terminals to reduce inventory
- Innovative panel mounting design holds connectors firmly in place
- Fully isolated contacts prevent terminal damage
- Fully polarized to completely prevent mismatching

Reference Information

Product Specification: PS-44300
Packaging: Tray
UL File No.: E29179
CSA File No.: LR19980
TUV License No.: R72040445
Mates With: 44300, 44428, 44432 and 45280
Use With: 43030
Designed In: Millimeters

Electrical

Dielectric Withstanding Voltage: 1500V AC
Insulation Resistance: 1000 Megohms min.

Mechanical

Contact Insertion Force: 14.7N (3.30 lb)
Contact Retention to Housing: 24.5N (5.50 lb)

Physical

Housing: Polyester, UL 94V-0

Circuits	Order No.
4	44133-0400
6	44133-0600
8	44133-0800
10	44133-1000
12	44133-1200
14	44133-1400

Circuits	Order No.
16	44133-1600
18	44133-1800
20	44133-2000
22	44133-2200
24	44133-2400

3.00mm (.118") Micro-Fit 3.0 BMI™ Panel-to-Panel Plug

44300
Dual Row

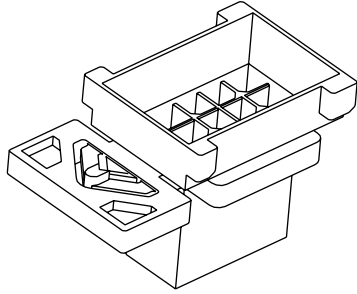

Features and Benefits

- 4 to 24 circuits for design flexibility
- Use standard Micro-Fit terminals to reduce inventory
- Innovative panel mounting design holds connectors firmly in place
- Fully isolated contacts prevent terminal damage
- Fully polarized to completely prevent mismatching

Reference Information

Product Specification: PS-44300
 Packaging: Bag
 UL File No.: E29179
 CSA File No.: LR19980
 TUV License No.: R72040445
 Mates With: 44133, 44764 and 44769
 Use With: 43031
 Designed In: Millimeters

Electrical

Dielectric Withstanding Voltage: 1500V AC
 Insulation Resistance: 1000 Megohms min.

Mechanical

Contact Insertion Force: 14.7N (3.30 lb)
 Contact Retention to Housing: 24.5N (5.50 lb)

Physical

Housing: Polyester, UL 94V-0

Circuits	Order No.
4	44300-0400
6	44300-0600
8	44300-0800
10	44300-1000
12	44300-1200
14	44300-1400

Circuits	Order No.
16	44300-1600
18	44300-1800
20	44300-2000
22	44300-2200
24	44300-2400

3.00mm (.118") Pitch Micro-Fit BMI CPI™ Board-to-Board and Wire-to-Board Header

45280
Dual Row, Vertical

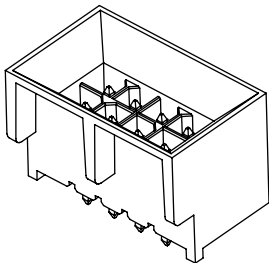

Features and Benefits

- Solderless board connection
- 4 to 24 circuits for design flexibility
- Fully isolated contacts prevent terminal damage
- Fully polarized to prevent mismatching

Reference Information

Product Specification: PS-44300
 Packaging: Tray
 UL File No.: E29179
 CSA File No.: LR19980A
 TUV File No.: R72040445
 Mates With: 44133, 44764 and 44769
 Designed In: Millimeters

Electrical

Voltage: 250V
 Current: 5.0A max.
 Contact Resistance: 30 milliohms max.
 Dielectric Withstanding Voltage: 1500V AC

Mechanical

Insertion Force to PCB: 10.9kgf max. (24 lbf) per terminal
 Retention Force to PCB: 3.6kgf max. (8lbf) per terminal
 Durability: 30 cycles

Physical

Housing: Glass-filled nylon, UL 94V-0
 Contact: Brass
 Plating: Contact Area—Tin or Gold
 Solder Tail Area—Tin or Tin/Lead
 Underplating—Nickel
 PCB Thickness: 2.34mm (.092") min.

Circuits	Order No.			Lead-free
	Tin	15µ" Gold	30µ" Gold	
4	45280-0401	45280-0452	45280-0453	Yes
6	45280-0601	45280-0652	45280-0653	
8	45280-0801	45280-0852	45280-0853	
10	45280-1001	45280-1052	45280-1053	
12	45280-1201	45280-1252	45280-1253	
14	45280-1401	45280-1452	45280-1453	
16	45280-1601	45280-1652	45280-1653	
18	45280-1801	45280-1852	45280-1853	
20	45280-2001	45280-2052	45280-2053	
22	45280-2201	45280-2252	45280-2253	
24	45280-2401	45280-2452	45280-2453	

Circuits	Order No.		Lead-free
	15µ" Gold	30µ" Gold	
4	45280-0402	45280-0403	No
6	45280-0602	45280-0603	
8	45280-0802	45280-0803	
10	45280-1002	45280-1003	
12	45280-1202	45280-1203	
14	45280-1402	45280-1403	
16	45280-1602	45280-1603	
18	45280-1802	45280-1803	
20	45280-2002	45280-2003	
22	45280-2202	45280-2203	
24	45280-2402	45280-2403	

3.00mm (.118") Pitch Micro-Fit CPI™ Wire-to-Board Header

44914
Dual Row, Vertical

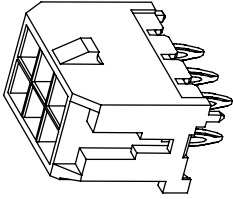

Features and Benefits

- Solderless board connection
- 2 to 24 circuits for design flexibility
- Fully isolated contacts prevent terminal damage
- Fully polarized to prevent mismatching

Reference Information

Product Specification: PS-43045
Packaging: Tray
UL File No.: E29179
CSA File No.: LR19980A
TUV File No.: R72040445
Mates With: 43025
Designed In: Millimeters

Electrical

Voltage: 250V
Current: 5.0A max.
Contact Resistance: 30 milliohms max.
Dielectric Withstanding Voltage: 1500V AC

Mechanical

Insertion Force to PCB: 10.7kgf max. (24 lbf) per terminal
Retention Force to PCB: 3.6kgf max. (8lbf) per terminal
Durability: 30 cycles

Physical

Housing: High-temperature LCP, UL 94V-0
Contact: Brass
Plating: Contact Area—Tin or Gold
Solder Tail Area—Tin or Tin/Lead
Underplating—Nickel
PCB Thickness: 2.34mm (.092") min.

Circuits	Order No.			Lead-free
	Tin	15µm Gold	30µm Gold	
2	44914-0201	44914-5202	44914-5203	Yes
4	44914-0401	44914-5402	44914-5403	
6	44914-0601	44914-5602	44914-5603	
8	44914-0801	44914-5802	44914-5803	
10	44914-1001	44914-6002	44914-6003	
12	44914-1201	44914-6202	44914-6203	
14	44914-1401	44914-6402	44914-6403	
16	44914-1601	44914-6602	44914-6603	
18	44914-1801	44914-6802	44914-6803	
20	44914-2001	44914-7002	44914-7003	
22	44914-2201	44914-7202	44914-7203	
24	44914-2401	44914-7402	44914-7403	

Circuits	Order No.		Lead-free
	15µm Gold	30µm Gold	
2	44914-0202	44914-0203	No
4	44914-0402	44914-0403	
6	44914-0602	44914-0603	
8	44914-0802	44914-0803	
10	44914-1002	44914-1003	
12	44914-1202	44914-1203	
14	44914-1402	44914-1403	
16	44914-1602	44914-1603	
18	44914-1802	44914-1803	
20	44914-2002	44914-2003	
22	44914-2202	44914-2203	
24	44914-2402	44914-2403	

E

Power Connectors

1.57mm (.062") Pin Diameter .062" Pin and Socket Female Crimp Terminal

Standard .062"

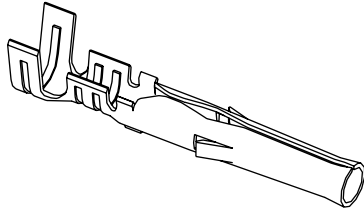

Features and Benefits

- Circular contact design for simple insertion
- Can be used with plug or receptacle housing
- Accommodates 18 to 30 gauge wire

Reference Information

Product Specification: PS-02-06
UL File No.: E29179
CSA File No.: LR19980

Electrical

Current: 5.0A
Contact Resistance: 3.2 milliohms max.

Mechanical

Mating: 15.75N max.
Mating Cycles: Tin—25 cycles max.
Gold—50 cycles max.

Physical

Contact: Brass or Phosphor Bronze
Plating: Tin, overall Gold or select Gold
Wire Size: See chart and product specification

Type	Plating	Crimp Wire Size	Insulation Diameter	Series	Order No.		Lead-free
					Chain	Loose	
Standard Brass .008"	Tin	18-24	1.52/3.05 (.060/.120)	1561	02-06-1101	02-06-1103	Yes
		24-30	1.02/2.29 (.040/.090)	1855	02-06-1131	02-06-1132	
	15µ" Gold	18-24	1.52/3.05 (.060/.120)	1561	02-06-5100	02-06-5103	
		24-30	1.02/2.29 (.040/.090)	1855	02-06-5130	02-06-5135	
	30µ" Gold	18-24	1.52/3.05 (.060/.120)	1561	02-06-5101	02-06-5102	
		24-30	1.02/2.29 (.040/.090)	1855	02-06-5138	02-06-5139	
	30µ" Gold Contact Tin Crimp	18-24	1.52/3.05 (.060/.120)	1561	02-06-5108	02-06-5109	
		24-30	1.02/2.29 (.040/.090)	1855	02-06-5147	02-06-5148	
Phos-Bronze	Tin .006"	18-24	1.52/3.05 (.060/.120)	4529	02-06-1104	02-06-1105	
		18-24	1.52/3.05 (.060/.120)	1787	02-06-1201	02-06-1202	
	Tin .008"	18-24	1.52/3.05 (.060/.120)	2189	02-06-1231	02-06-1232	
		24-30	1.02/2.29 (.040/.090)	2189	02-06-1231	02-06-1232	
	.006" Gold (15µ")	18-24	1.52/3.05 (.060/.120)	4529	02-06-5207	02-06-5208	
		.008" Gold (15µ")	18-24	1.52/3.05 (.060/.120)	1787	02-06-5201	02-06-5202
.008" PC Tail Brass for Standard .062" Housings Only	Tin			1779		02-06-7103	
	30µ" Gold Tin Tail Area			1779		02-06-7104	

Note: .006 Phosphor Bronze stock recommended for versions 15 circuits and larger

1.57mm (.062") Pin Diameter .062" Pin and Socket Male Crimp Terminal

Standard .062"

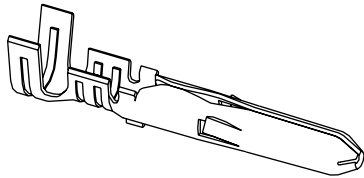

Features and Benefits

- Circular contact design for simple insertion
- Can be used with plug or receptacle housing
- Accommodates 18 to 30 gauge wire

Reference Information

Product Specification: PS-02-06
UL File No.: E29179
CSA File No.: LR19980

Electrical

Current: 5.0 A
Contact Resistance: 3.2 milliohms max.

Mechanical

Mating Force: 15.57N max.
Mating Cycles: Tin—25 cycles max.
Gold—50 cycles max.

Physical

Contact: Brass or Phosphor Bronze
Plating: Tin or Gold
Wire Size: See chart and product specification

Type	Plating	Crimp Wire Size	Insulation Diameter	Series	Order No.		Lead-free
					Chain	Loose	
Standard Brass .008"	Tin	18-24	1.52/3.05 (.060/.120)	1560	02-06-2101	02-06-2103	Yes
		24-30	1.02/2.29 (.040/.090)	1854	02-06-2131	02-06-2132	
	15µ" Gold	18-24	1.52/3.05 (.060/.120)	1560	02-06-6100	02-06-6103	
		24-30	1.02/2.29 (.040/.090)	1854	02-06-6130	02-06-6135	
	30µ" Gold	18-24	1.52/3.05 (.060/.120)	1560	02-06-6101	02-06-6102	
		24-30	1.02/2.29 (.040/.090)	1854	02-06-6138	02-06-6139	
	30µ" Gold Contact Tin Crimp	18-24	1.52/3.05 (.060/.120)	1560	02-06-6118	02-06-6119	
		24-30	1.02/2.29 (.040/.090)	1854	02-06-6143	02-06-6144	
.008" Phosphor Bronze	Tin	18-24	1.52/3.05 (.060/.120)	1786	02-06-2201	02-06-2202	
	Gold (15µ")	18-24	1.52/3.05 (.060/.120)	1786	02-06-6201	02-06-6202	
.008" PC Tail Brass for Standard .062" Housings Only	Tin			1778	02-06-8103		
	30µ" Gold Tin Tail Area			1778		02-06-6122	

Note: .006 Phosphor Bronze stock recommended for versions 15 circuits and larger

3.68mm (.145") Pitch .062" Pin and Socket Crimp Terminal Housing Receptacle

Standard .062"

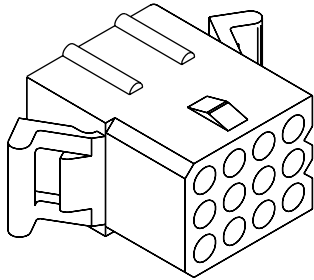

Features and Benefits

- Friction lock
- Panel and PCB mountable
- Polarized housing assures proper mating
- Male and female terminals may be used in receptacle housing

Reference Information

Product Specification: PS-02-06
UL File No.: E29179
CSA File No.: LR19980
Mates With: Standard .062" plug
Use With: Standard .062" terminal

Electrical

Voltage: 250V
Current: See chart

Mechanical

Contact Retention to Housing: 88.96N min.

Physical

Housing: Nylon 6/6, UL 94V-2

Circuits	Series	Order No.		Amperes per Circuit
		Panel Mount	Free Hanging	
1	1625	N/A	03-06-1011	5.0
2		03-06-1022	03-06-1023	
3		03-06-1038	03-06-1032	
4 (1 x 4)		03-06-1041	03-06-1042	
4 (2 x 2)	2004	03-06-1043	03-06-1044	
5		03-06-1055	03-06-1056	
6	1625	03-06-1061	03-06-1062	
9		03-06-1091	03-06-1092	
12		03-06-1121	03-06-1122	
15		03-06-6155	03-06-1152	
24		03-06-1241	N/A	
36*		1772	03-06-1361	03-06-1362

* 36-circuit receptacle is on a 4.19mm (.165") pitch

3.68mm (.145") Pitch .062" Pin and Socket Crimp Terminal Housing Plug

Standard .062"

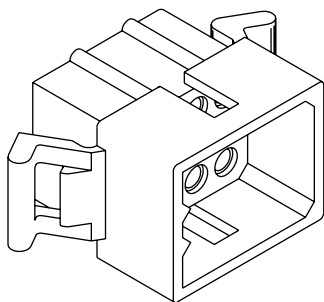

Features and Benefits

- Friction lock
- Panel and PCB mountable
- 1-piece strain relief available, 41316 series
- Polarized housing assures proper mating
- Male and female terminals may be used in plug housing

Reference Information

Product Specification: PS-02-06
UL File No.: E29179
CSA File No.: LR19980
Mates With: Standard .062" receptacle
Use With: Standard .062" terminal

Electrical

Voltage: 250V
Current: See chart

Mechanical

Contact Retention to Housing: 88.96N min.

Physical

Housing: Nylon 6/6, UL 94V-2

Circuits	Series	Order No.		Amperes per Circuit
		Panel Mount	Free Hanging	
1	1625	N/A	03-06-2011	5.0
2		03-06-2024	03-06-2023	
3		03-06-2033	03-06-2032	
4 (1 x 4)		03-06-2041	03-06-2042	
4 (2 x 2)	2004	03-06-2043	03-06-2044	
5		03-06-2054	03-06-2055	
6	1625	03-06-2062	03-06-2061	
9		03-06-2091	03-06-2092	
12		03-06-2121	03-06-2122	
15		03-06-2151	03-06-2152	
24		03-06-2241	03-06-2242	
36*		1772	03-06-2361	03-06-2362

* 36-circuit plug is on a 4.19mm (.165") pitch

2.50mm (.098") Pitch Wire-to-Board Receptacle

94539

**3 Circuit
With Secondary Lock**

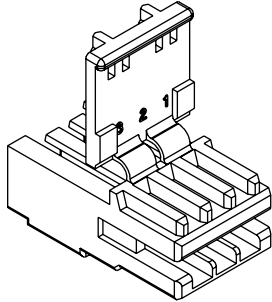

Features and Benefits

- Rast 2.5 crimping technology
- Used for domestic appliances
- Plastic latch
- Polarized

Reference Information

Product Specification: PS-94539-005
Packaging: Box
Use With: 94539-1000
Designed In: Millimeters

Electrical

Voltage: 65V
Current: 3.0mA
Contact Resistance: 30 milliohms max.
Dielectric Withstanding Voltage: 500V
Insulation Resistance: 1000 Megohms min.

Mechanical

Contact Retention Force: 3N (0.67 lb) min.
Contact Retention to Housing: 60N (13.49 lb) min.
Mating Force: 6N (1.35 lb) max.
Unmating Force: 30N (6.74 lb) min.
Normal Force: 1N (0.22 lb) min.
Durability: 20 cycles

Physical

Housing: PA 66, UL 94V-2

Order No.	Color	Polarized	Lead-free
94539-9003	Natural	No	Yes
94539-9103	Black		
94539-9203	Red		
94539-9303	Green		
94539-9133	Black		
94539-9213	Red	Yes	
94539-9443	Blue		

Note: Please contact Molex for 8 circuit version

www.molex.com/customer.html?seriesNumber=94539

Wire-to-Board Crimp Terminals Strain Relief PC Board Terminals

4706/4811

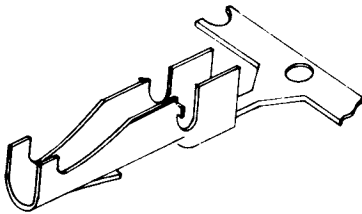

Features and Benefits

- Snap-lock secures wire to PC board for wave soldering
- No additional contact resistance
- Wire soldered directly to board
- Economical means of hand-wiring boards
- Eliminates eyelets on PC boards

Reference Information

Product Specification: PS-4706 and PS-4811

Physical

Contact: Brass
Plating: See table

Wire Size AWG	Maximum Insulation Diameter	Engineering No.	Order No.	Plating	Terminal Progression	Application Tooling TM-42™			Dimension		Lead-free
						Die Only	Press and Die	Spare Tooling Kit	Board Thickness	PC Board Hole Size	
16-18	3.05 (.120)	4706	02-09-2105	Tin	11.20 (.440)	11-40-2042	11-04-0293	11-40-3042	1.57 (.062)	2.49 (.098)	Yes
18-24		4706-3	02-07-2101			11-40-2043	11-04-0295	11-40-3043		1.91 (.075)	
22-24	2.54 (.100)	4811	16-02-0037		11-40-2029	11-04-0277	11-40-3029	1.30 (.051)			
22-26	1.52 (.060)	4811-1	16-02-0034		11-40-2039	11-04-0279					

Panel Grounding Clip

42172

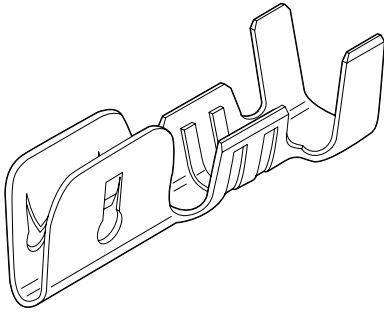

Features and Benefits

- Provides reliable ground to chassis without fasteners
- Simple to install
- Requires no secondary fasteners
- Accepts single and dual crimps
- Secondary grounding applications only
- Rust-resistant Stainless Steel

Reference Information

UL File No.: E126412
CSA File No.: LR19980A

Physical

Contact: .020" Stainless Steel

Minimum Panel Thickness	Maximum Panel Thickness	Wire Range AWG	Dual Crimp Capabilities	Engineering No.	Order No.	Lead-free
0.38 (.015)	0.89 (.035)	16-18	(2) 18 AWG, or (1) 18 and (1) 16 AWG	42172-G1	40-06-2024	Yes
		14	(2) 16 AWG	42172-AA1	40-06-2014	
		16-18	(2) 18 AWG, or (1) 18 and (1) 16 AWG	42172-A1	40-06-2003	
0.51 (.020)	0.76 (.030)	16-18	(2) 18 AWG, or (1) 18 and (1) 16 AWG	42172-F1	40-06-2017	
		14	(2) 16 AWG	42172-BB1	40-06-2015	
0.89 (.035)	1.27 (.050)	16-18	(2) 18 AWG, or (1) 18 and (1) 16 AWG	42172-B1	40-06-2005	
				42172-C1	40-06-2013	
1.52 (.060)	1.91 (.075)					

www.molex.com/customer.html?seriesNumber=42172

3.18mm (.125") Diameter Pin Cluster Block Connector Terminal

35454

For Magnet Wire

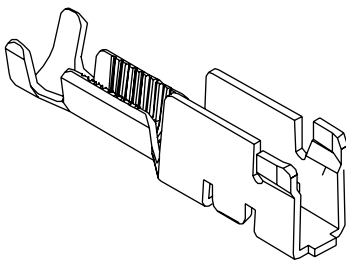

Features and Benefits

- Crimped with magnet wire
- One-step crimping operation (no stripping operation)
- Sharp edge serration for good electrical contact

Reference Information

Product Specification: PS-35548
Packaging: Reel
UL File No.: E29179
Use With: 35548
Designed In: Millimeters

Electrical

Voltage: 230V
Current: 20.0A
Contact Resistance: 5 milliohms max.
Dielectric Withstanding Voltage: 1000V
Insulation Resistance: 1000 Megohms min.

Mechanical

Unmating Force: 11.2N (2.8 lb) min.
Durability: 30 cycles

Physical

Contact: Phosphor Bronze
Plating: Tin
Wire Gauge: 400 to 8000 CMA

Order No.	Wire Range (CMA)	Lead-free
35454-8702	400-1600	Yes
35454-8902	1500-4200	
35454-8002	4000-8000	

3-in-1 Combo Connector Mini-Fuse/Power 2.50mm (.098")

87527

Right Angle

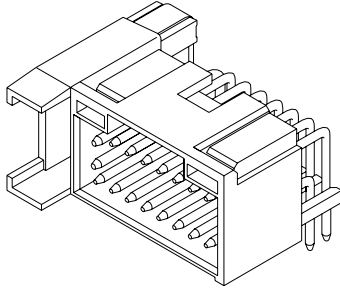

Circuits	Order No.	Lead-free
16	87527-1612	Yes

Features and Benefits

- Size 16 circuits
- 3-in-1 combo (Signal, Power & Mini-Fuse Socket)
- Low profile

Reference Information

Product Specification: PS-87527-001
Packaging: Bag
Designed In: Millimeters

Electrical

Voltage: 250V max.
Current: 4.0A max.
Contact Resistance: 20 milliohms max.
Dielectric Withstanding Voltage: 1000V AC/1 min.
Insulation Resistance: 1000 Megohms min.

Physical

Housing: Nylon, UL94-V2
Contact: Brass
Plating: Tin over Nickel

www.molex.com/product/io/

2.00mm (.079") Pitch Battery Connector

47182

Surface Mount

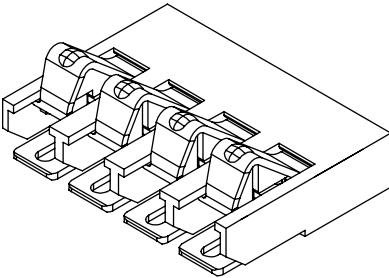

Circuits	Order No.	Lead-free
2	47182-1001	Yes
4	47182-0001	

Features and Benefits

- Board-to-board connector for battery and power applications
- Rugged durability up to 10,000 cycles
- Maximum current of 2.3A per circuit
- Strong terminal design provides higher contact force

Reference Information

Product Specification: PS-47182-001
Packaging: Tape on reel
Designed In: Millimeters

Electrical

Voltage: 200V
Current: 1.0A
Contact Resistance: 25 milliohms max.
Dielectric Withstanding Voltage: 100V AC
Insulation Resistance: 500 Megohms min.

Mechanical

Normal Force: 1.03N
Durability: 10,000 cycles

Physical

Housing: High-temperature thermoplastic, UL 94V-0
Contact: Copper Alloy
Plating: Contact Area—30 μ " Gold
Solder Tail Area—Gold Flash
Underplating: Nickel

2.50mm (.098") Pitch Battery Connector

47204
Surface Mount

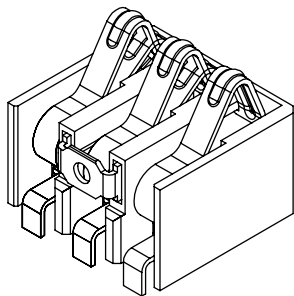

Order No.	Lead-free
47204-0001	Yes

Features and Benefits

- Board-to-board connector for battery and power applications
- Rugged durability up to 10,000 cycles
- Maximum current of 2.3A per circuit
- Strong terminal design provides higher contact force

Reference Information

Product Specification: PS-47204-001

Packaging: Tape on reel

Designed In: Millimeters

Electrical

Voltage: 200V

Current: 1.0A

Contact Resistance: 25 milliohms max.

Dielectric Withstanding Voltage: 100V AC

Insulation Resistance: 500 Megohms min.

Mechanical

Normal Force: 0.34N

Durability: 10,000 cycles

Physical

Housing: High-temperature thermoplastic, UL 94V-0

Contact: Copper Alloy

Plating: Contact Area—16 μ ." Gold

Solder Tail Area—Tin

Underplating: Nickel

www.molex.com/customer.html?seriesNumber=47204

3.90mm (.153") Pitch Battery Connector

94337
4 Circuit
Single Row, SMT

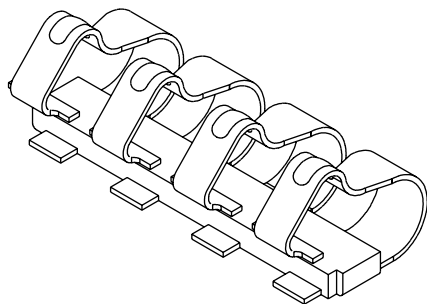

Order No.	Lead-free
94337-5014	Yes

Features and Benefits

- Electrical connection between main battery and mobile phone
- SMT lead configuration
- PCB top mounting
- Insert molded
- Pick-and-place area

Reference Information

Product Specification: PS-94337-005

Packaging: Tape and reel

Designed In: Millimeters

Electrical

Voltage: 200V

Current: 1.0A

Contact Resistance: 25 milliohms max

Dielectric Withstanding Voltage: 1000V

Insulation Resistance: 1000 Megohms min.

Mechanical

Normal Force: 2.2N (0.49 lb) min.

Durability: 10,000 cycles

Physical

Housing: Black LCP

Contact: Beryllium Copper Alloy

Plating: Contact Area—Selective Gold over Palladium Nickel

Solder Tail Area—Selective Tin

Underplating—Nickel overall